

LÁTKOVÉ ROLETY  
**PURE**

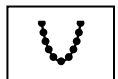

## Ikony



řetízkové ovládání



motor A



motor A



motor S



motor S



motor P



rádiová technologie A



rádiová technologie S

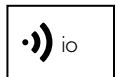

rádiová technologie S



montážní profil



kazeta



integrovaná baterie



externí baterie

## Legenda, kódy

*-WM*

montáž stěna

*-CM*

montáž strop

*-A*

standadní odvíjení látky - látka za trubkou

*-B*

kontra navíjení látky - látka před trubkou

*-L*

ovládání vlevo

*-R*

ovládání vpravo

*-FIN..*

zátěžová lišta

*-RT..*

rádiové ovládání

*-MP*

montážní profil

*-CH..*

řetízkové ovládání

*-MOT..*

motorické ovládání

*-B..*

barevné provedení konzol

*-CEXIT*

vývod kabelu

*..S*

hranatá kazeta

*..R*

kulatá kazeta

*-CS..*

vodící lanka

## Základní rozměry látkových rolet

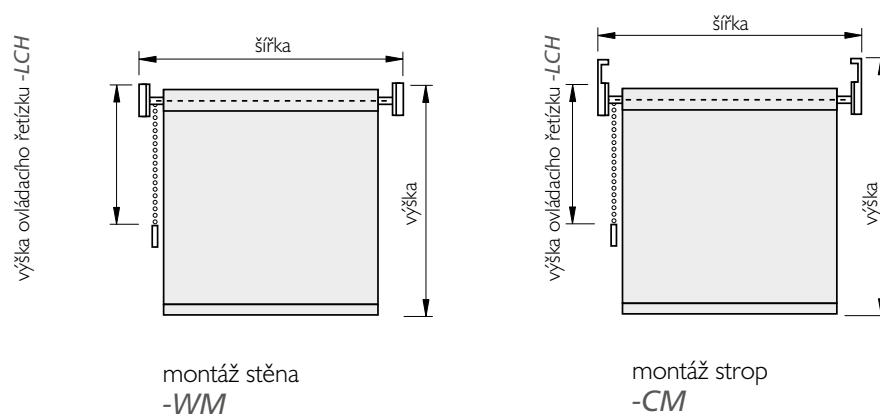

**!**

jestliže šířka rolety je menší než 1/3 výšky, nemůžeme garantovat správnou funkci rolety

jestliže není určený typ montáže, standardem je montáž stěna

šířka rolety je celková šířka včetně všech krycích dílů konzol, profilů a boxů

ovládání řetízkem musí být v souladu s normou EN13120-Ochrana proti nebezpečí uškrcení. Dodaná výška ovládání a event. dodané bezpečnostní prvky jí budou odpovídat

## Možnosti odvíjení látky

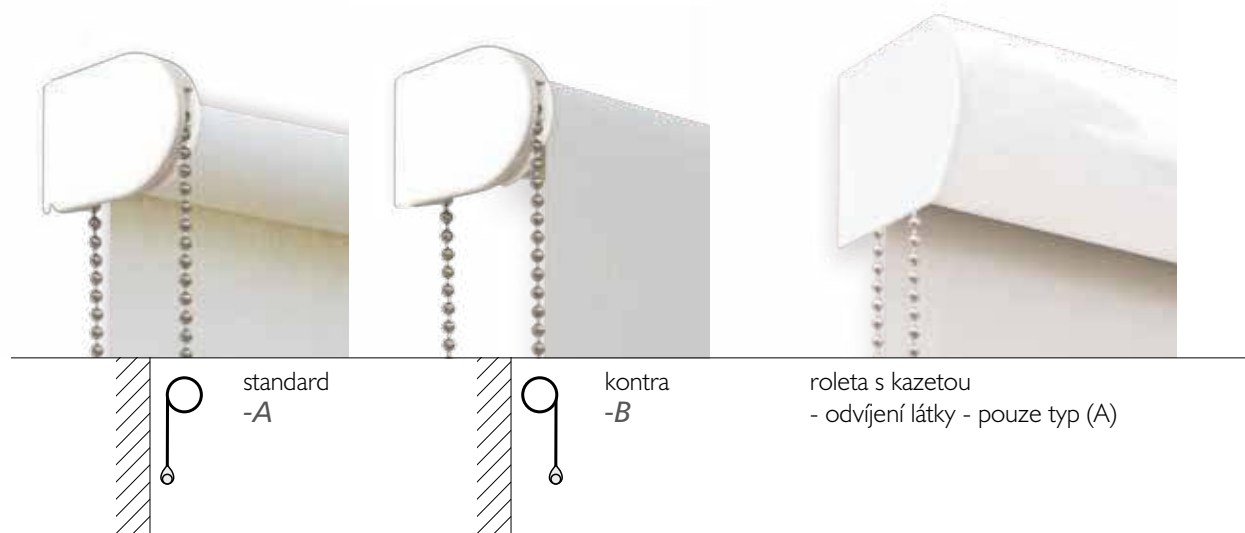

## Určení strany ovládání

strana ovládání se určuje při pohledu z interiéru, čelem k roletě





### PURE 32

objednávací kód  
LRU32-CH..



**-B01** -B04 -B10 **-BRAL**

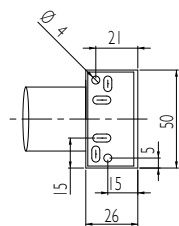
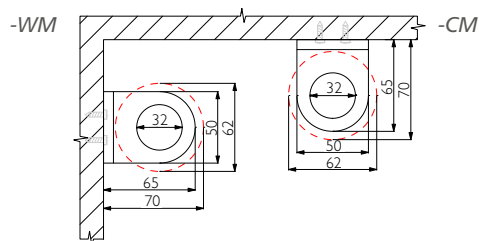
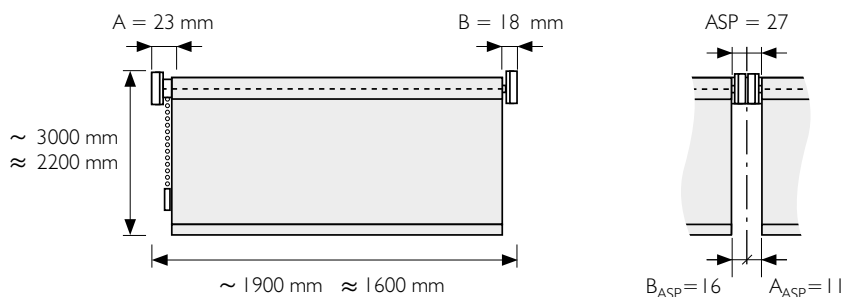

zátěžová lišta

sdrúžené rolety

závaží řetízku

řetízek

**-FINC25**

**-ASB..**

**-WE..**

**CHNI**

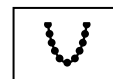

### PURE 40

objednávací kód  
LRU40-CH..



**-B01** -B04 -B10 **-BRAL**

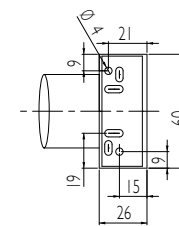
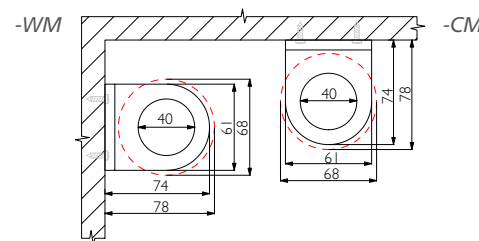
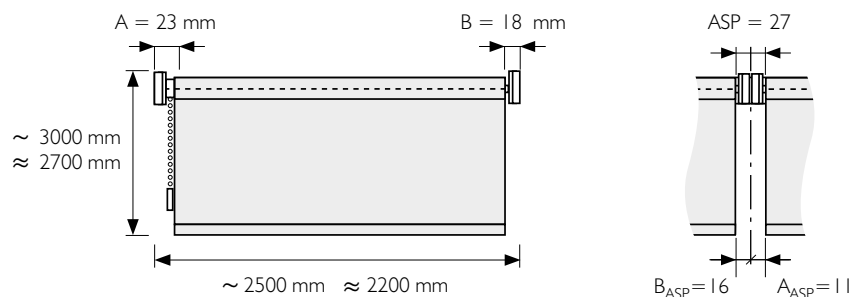

zátěžová lišta

sdrúžené rolety

závaží řetízku

řetízek

**-FINC25**

**-ASB..**

**-WE..**

**CHNI**

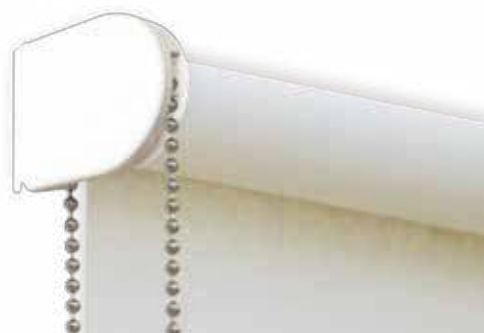

## PURE 47

objednávací kód  
LRU47-CH..



**-B01**   **-B04**   **-B10**   **-BRAL**

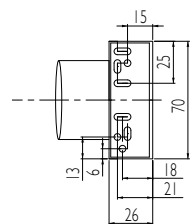
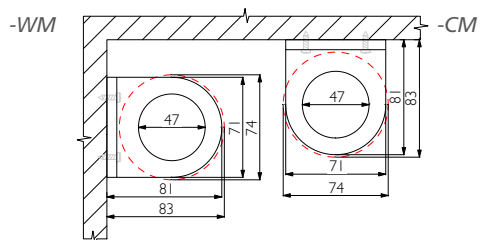
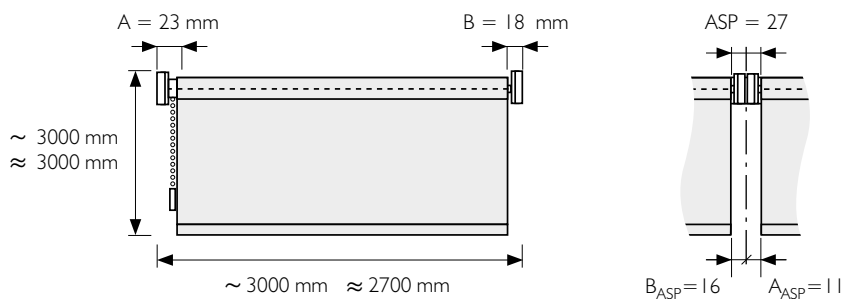

zátěžová lišta

sdrúžené rolety

závaží řetízku

řetízek

**-FINC25**

**-ASB..**

**-WE..**

**-CHNI**



## PURE 54

objednávací kód  
LRU54-CH..



**-B01**   **-B04**   **-B10**   **-BRAL**

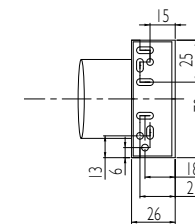
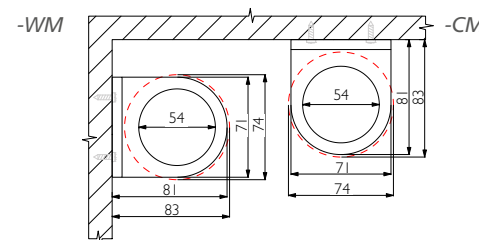
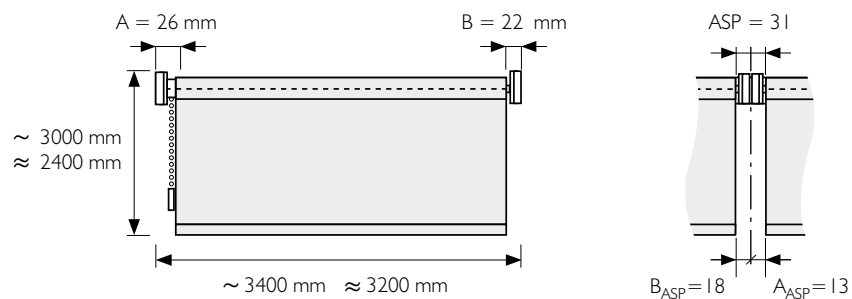

zátěžová lišta

sdrúžené rolety

závaží řetízku

řetízek

**-FINC25**

**-ASB..**

**-WE..**

**-CHNI**



### PURE 40

objednávací kód  
LRU40MP-CH..



-B01



-B04



-B10



-BRAL

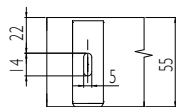
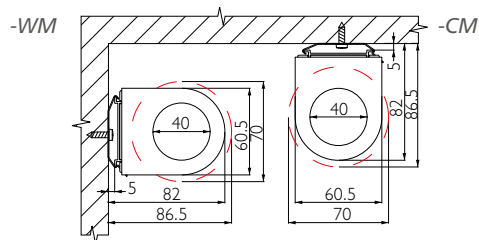
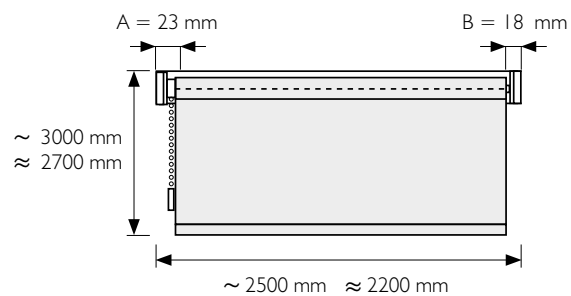

montážní profil

zátěžová lišta

závaží řetízku

řetízek

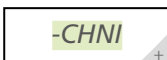
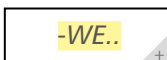

### PURE 47

objednávací kód  
LRU47MP-CH..



-B01



-B04



-B10



-BRAL

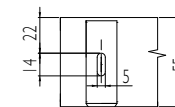
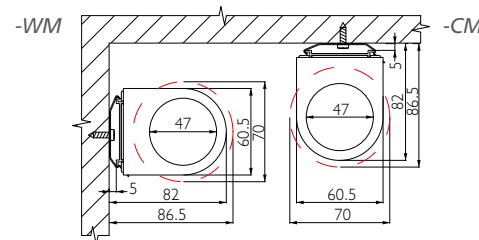
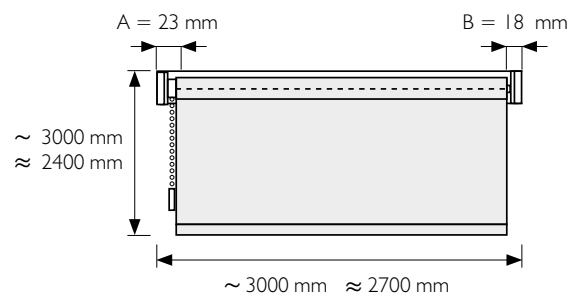

montážní profil

zátěžová lišta

závaží řetízku

řetízek

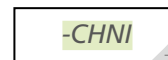
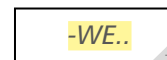

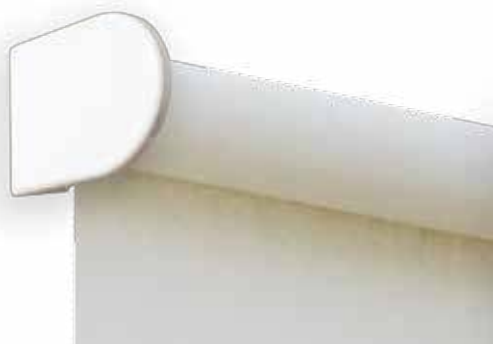
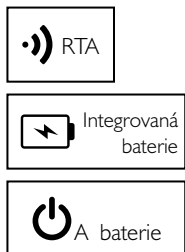

**PURE 40**  
objednávací kód  
**LRU40-MOT12RTA**

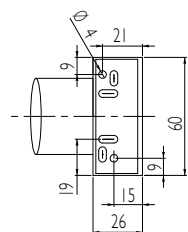
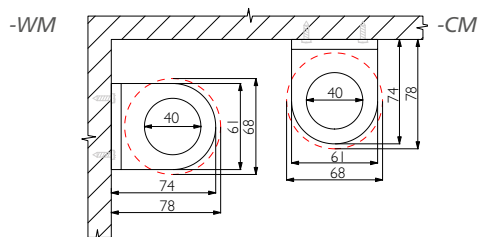
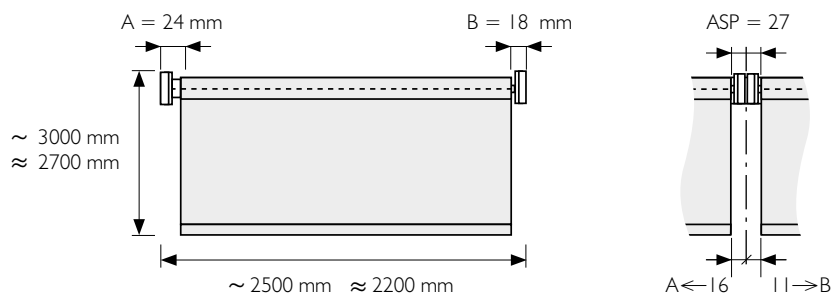

zátěžová lišta

sdrúžené rolety

dálkový ovladač RTA

**-FINC25**

**-ASB..**

**SENDA1**

nabíječka baterií

bateriový motor RTA

**CHAR12A**

**-MOT12RTA**



**PURE 40**  
objednávací kód  
**LRU40MP-MOT12RTA**

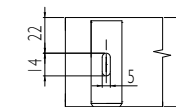
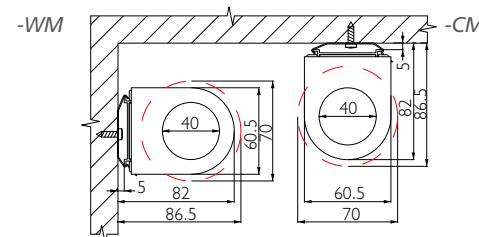
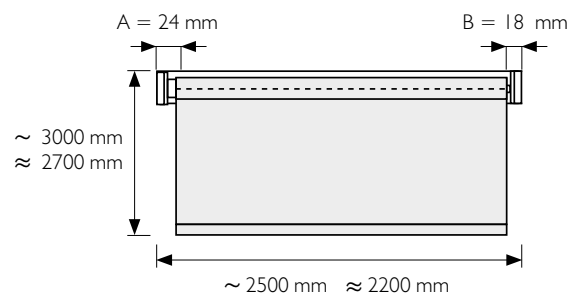

montážní profil

zátěžová lišta

dálkový ovladač RTA

nabíječka baterií

**-MP**

**-FINC25**

**SENDA1**

**CHAR12A**

bateriový motor RTA

**-MOT12RTA**

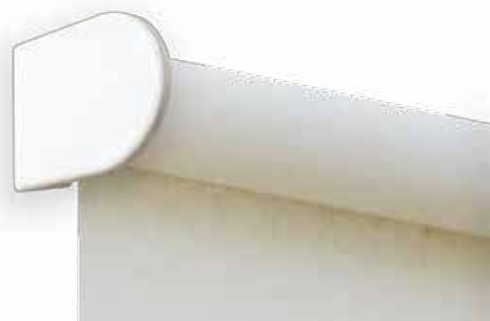

**PURE 47**  
objednávací kód  
**LRU47-MOTSIA**

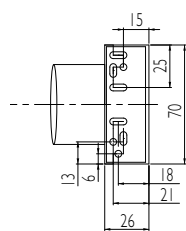
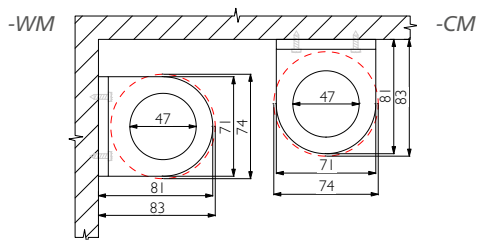
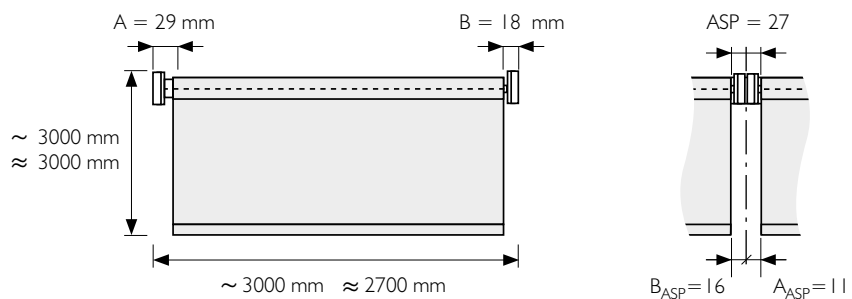
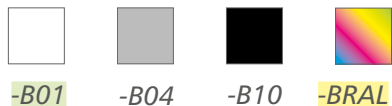

zátěžová lišta

sdrúžené rolety

motor A

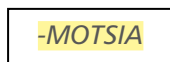
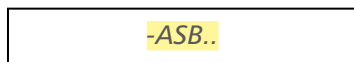

**PURE 47**  
objednávací kód  
**LRU47MP-MOTSIA**

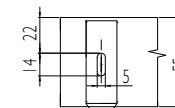
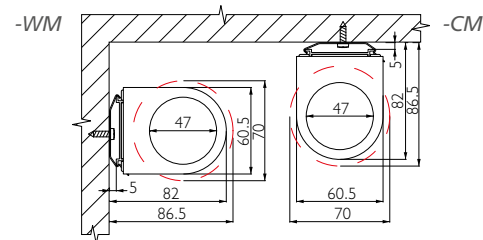
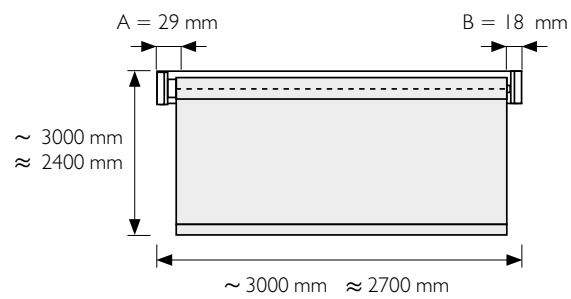
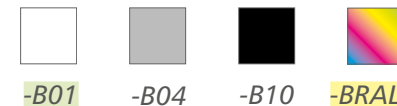

montážní profil

zátěžová lišta

motor A

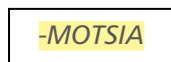



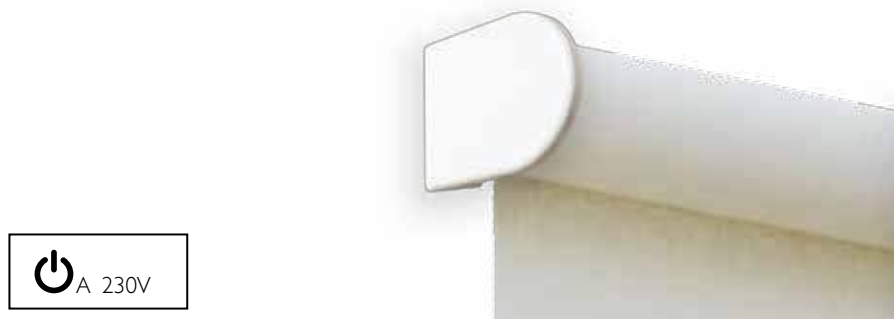

A 230V

**PURE 54**  
objednací kód  
**LRU54-MOTSIA**

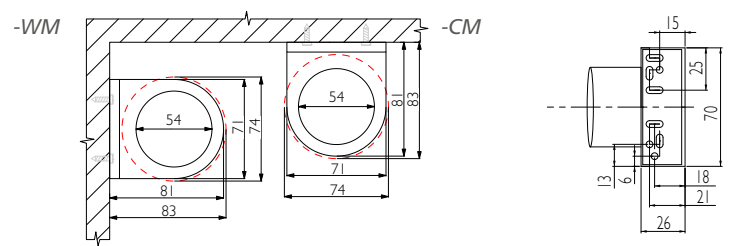
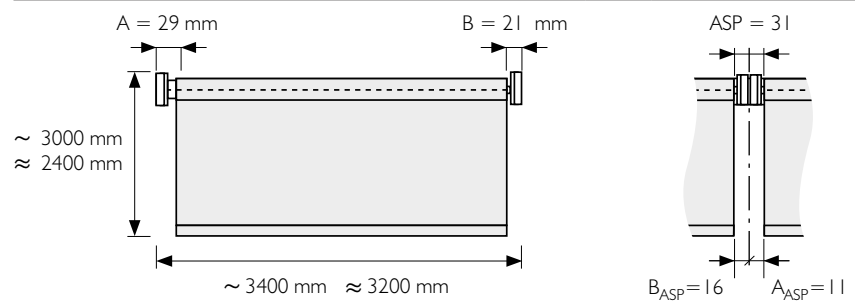

zátěžová lišta **-FINC25** sdrúžené rolety **-ASB..** motor A **-MOTSIA**

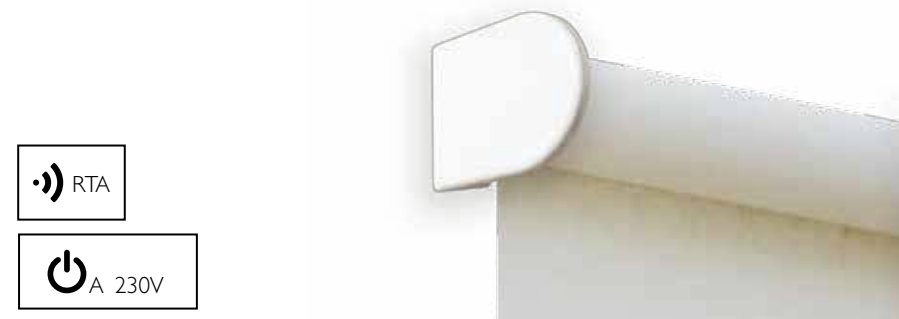

RTA

A 230V

**PURE 47**  
objednací kód  
**LRU47-MOTSIRTA**

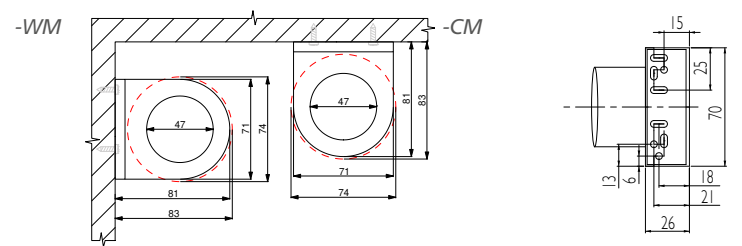
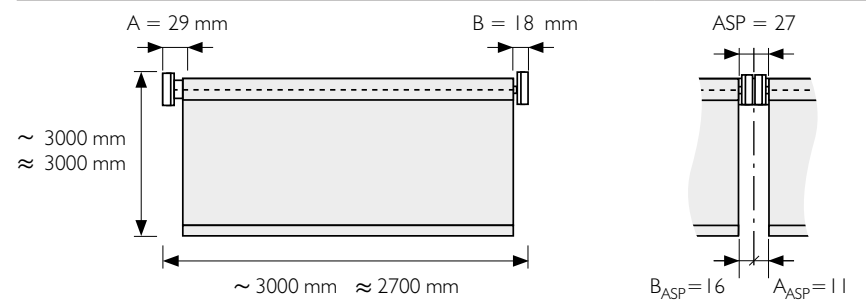

zátěžová lišta **-FINC25** sdrúžené rolety **-ASB..** dálkový ovladač RTA **SENDIA1**

motor RTA **-MOTSIRTA**

MP

RTA

A 230V

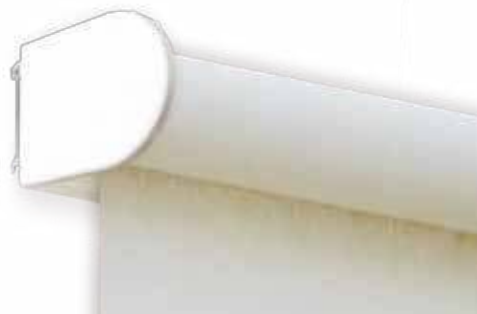

## PURE 47

objednávací kód  
LRU47MP-MOTSIRTA



-B01



-B04



-B10



-BRAL

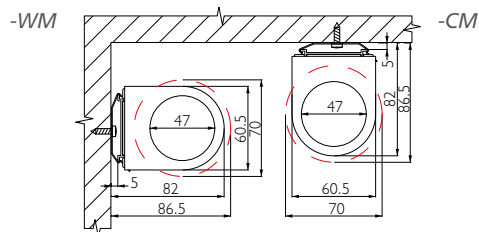
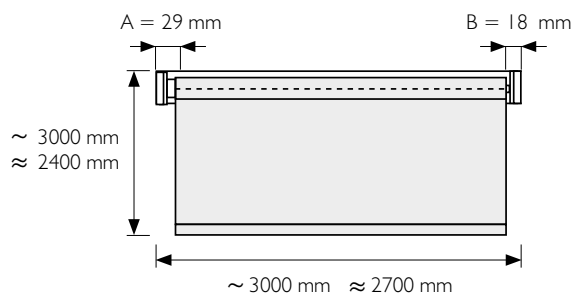

montážní profil

zátěžová lišta

dálkový ovladač RTA

motor RTA

-MP

-FINC25

SENDA1

-MOTSIRTA

RTA

A 230V

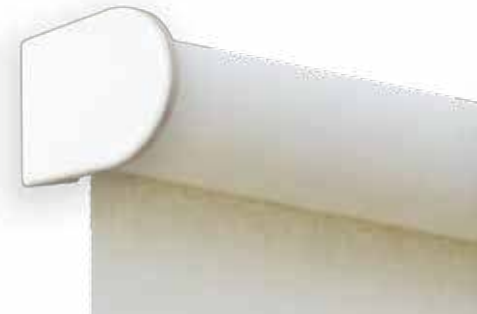

## PURE 54

objednávací kód  
LRU54-MOTSIRTA



-B01



-B04



-B10



-BRAL

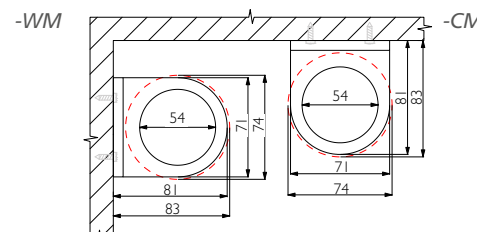
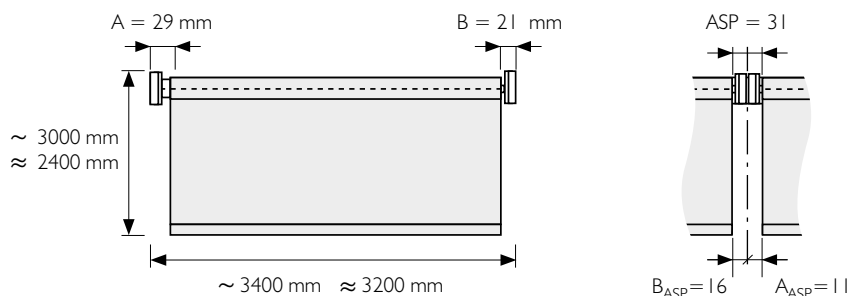

zátěžová lišta

sdrúžené rolety

dálkový ovladač RTA



-FINC25

-ASB..

SENDA1

motor RTA

-MOTSIRTA

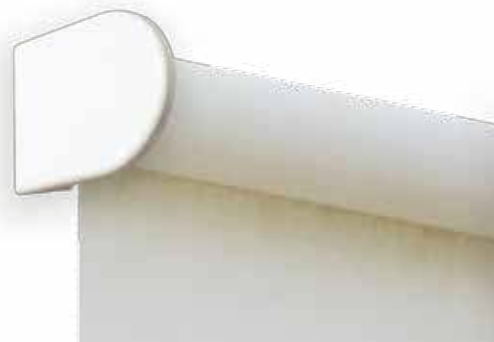

-  RTS
-  Externí baterie
-  S baterie





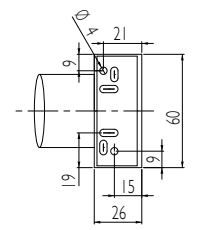
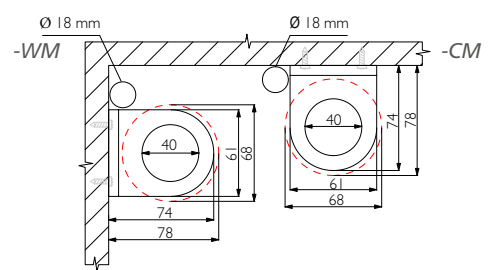
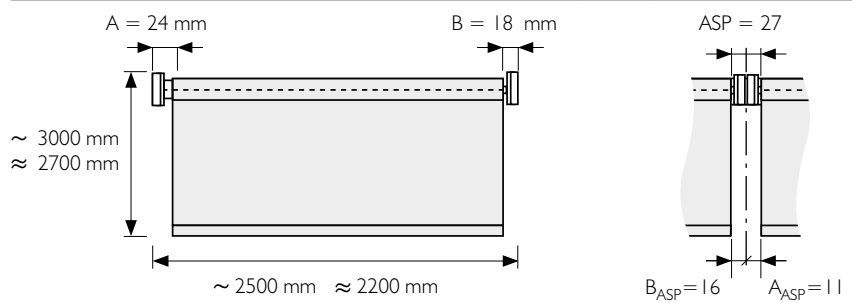

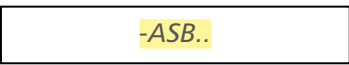
**PURE 40**  
objednávací kód  
**LRU40-MOT12IRTS**

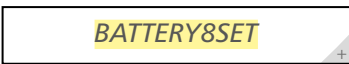
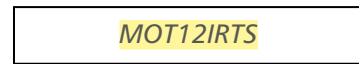
-  -B01
-  -B04
-  -B10
-  -BRAL







- |   |   |   |
|---|---|---|
| zátěžová lišta  | sdrúžené rolety   | dálkový ovladač RTS   |
|  |  |  |
| sada baterií  | bateriový motor RTS   |   |
|  |  |   |

-  MP
-  RTS
-  Externí baterie
-  S baterie



**PURE 40**  
objednávací kód  
**LRU40MP-MOT12IRTS**

-  -B01
-  -B04
-  -B10
-  -BRAL

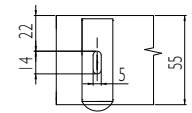
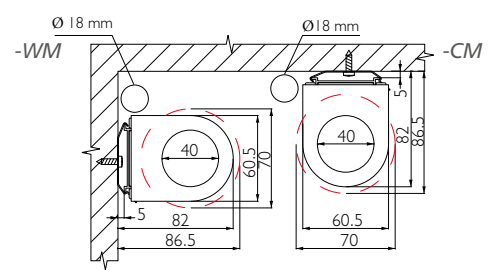
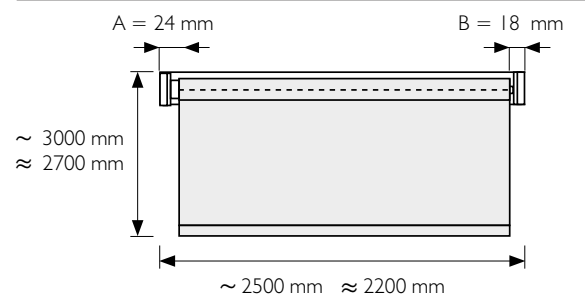

- |   |   |   |
|---|---|---|
| montážní profil   | zátěžová lišta  | dálkový ovladač RTS   |
|  |  |  |
| sada dobíjecích baterií   |   | bateriový motor RTS   |
|  |   |  |

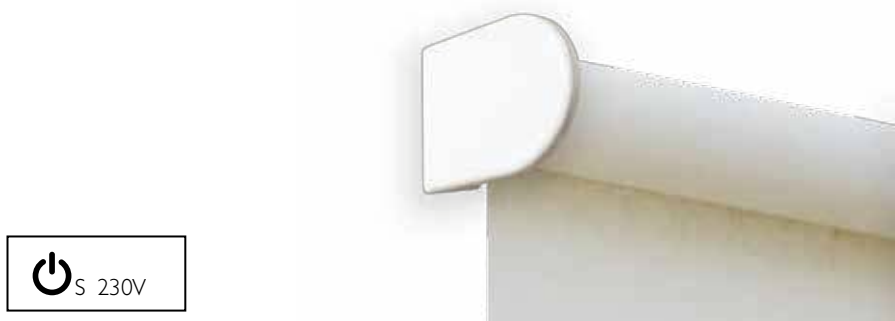

**PURE 47**  
objednávací kód  
**LRU47-MOTSIS**

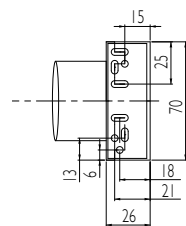
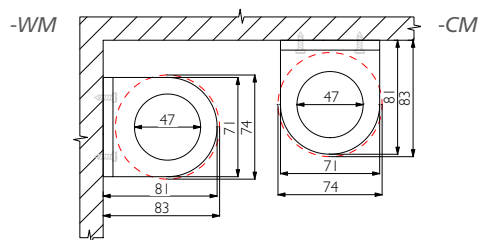
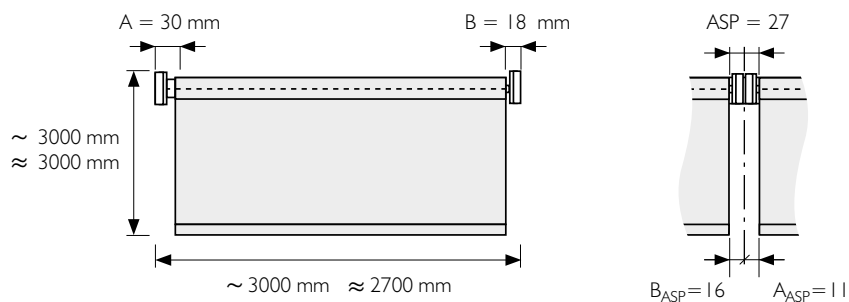
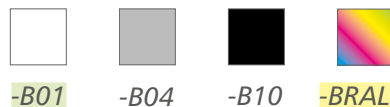

zátěžová lišta

sdrúžené rolety

motor S

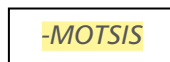
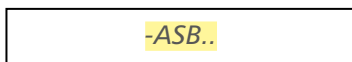

**PURE 47**  
objednávací kód  
**LRU47MP-MOTSIS**

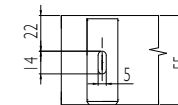
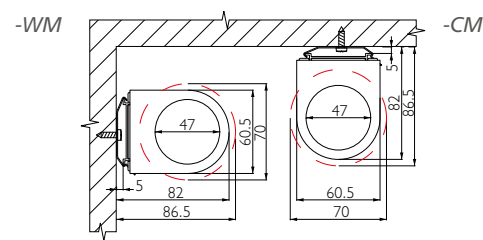
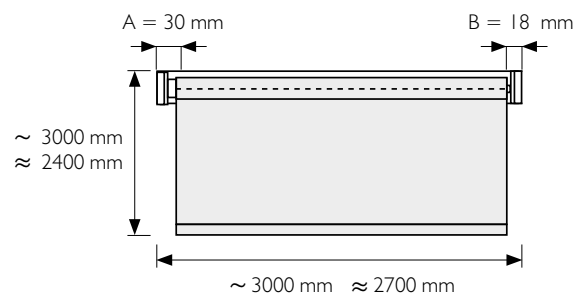

montážní profil

zátěžová lišta

motor S

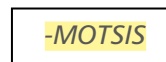
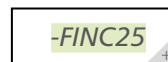

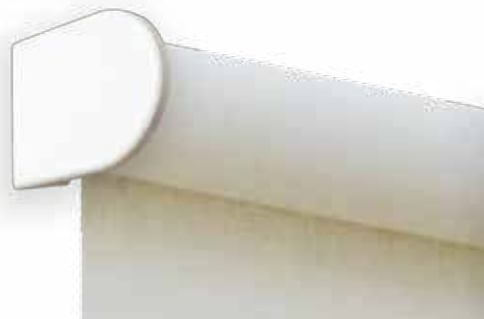

## PURE 54

objednávací kód  
LRU54-MOTSIS



**-B01**   **-B04**   **-B10**   **-BRAL**

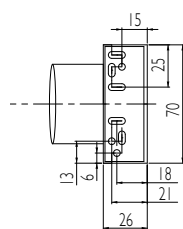
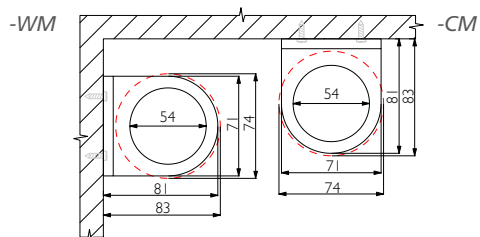
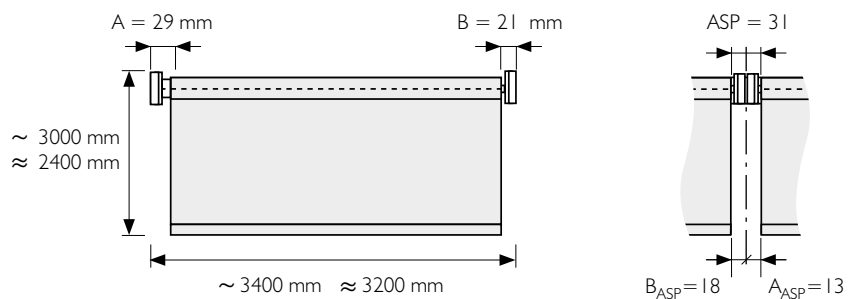

zátěžová lišta

sdrúžené rolety

motor S

**-FINC25**

**-ASB..**

**-MOTSIS**

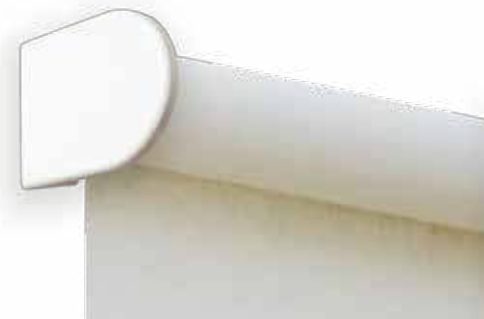

## PURE 47

objednávací kód  
LRU47-MOTSIRTS



**-B01**   **-B04**   **-B10**   **-BRAL**

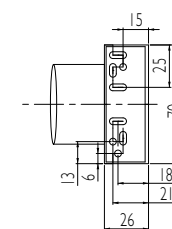
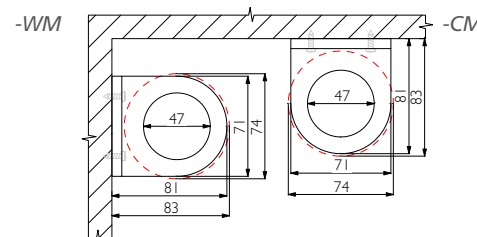
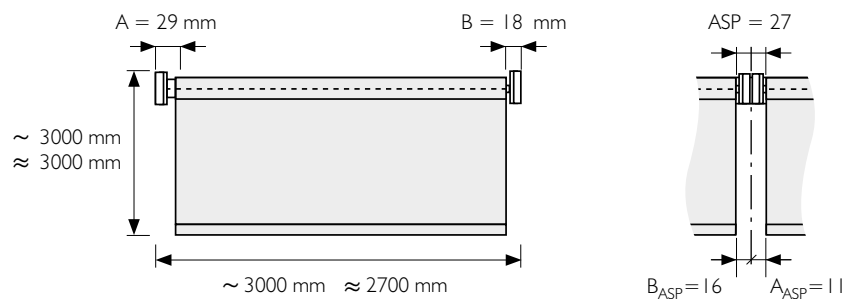

zátěžová lišta

sdrúžené rolety

dálkový ovladač RTS

**-FINC25**

**-ASB..**

**TELIS1W**

motor RTS

**-MOTSIRTS**

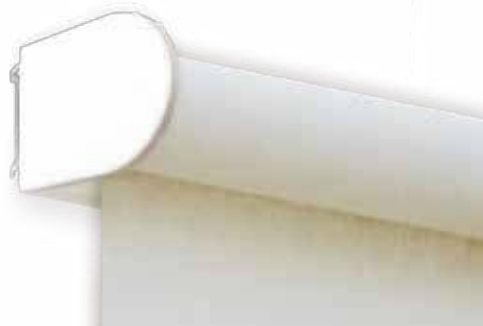

**PURE 47**  
objednávací kód  
**LRU47MP-MOTSIRTS**

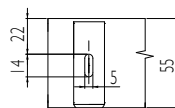
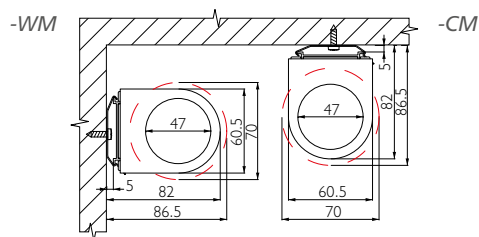
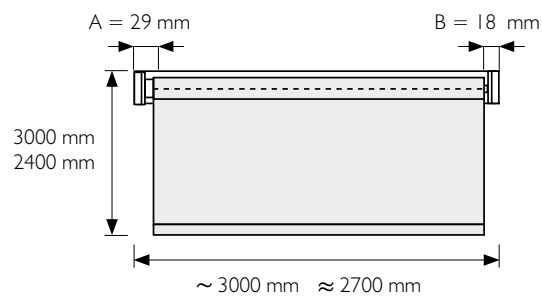

montážní profil

zátěžová lišta

dálkový ovladač RTS

motor RTS

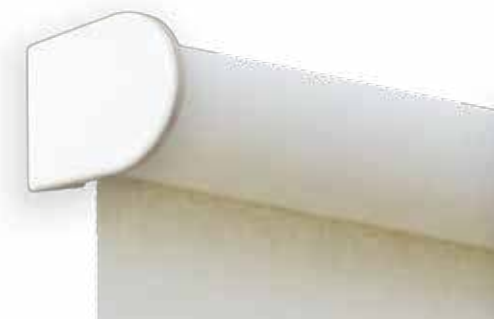
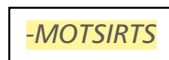
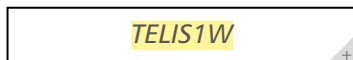

**PURE 54**  
objednávací kód  
**LRU54-MOTSIRTS**

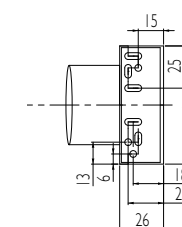
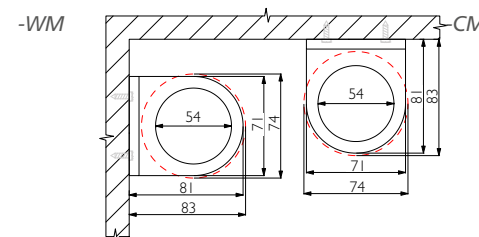
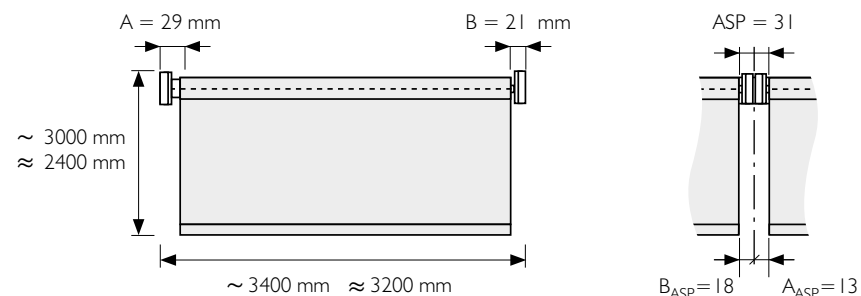

zátěžová lišta

sdrúžené rolety

dálkový ovladač RTS

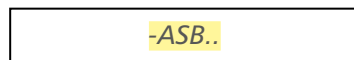

motor RTS

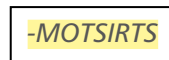

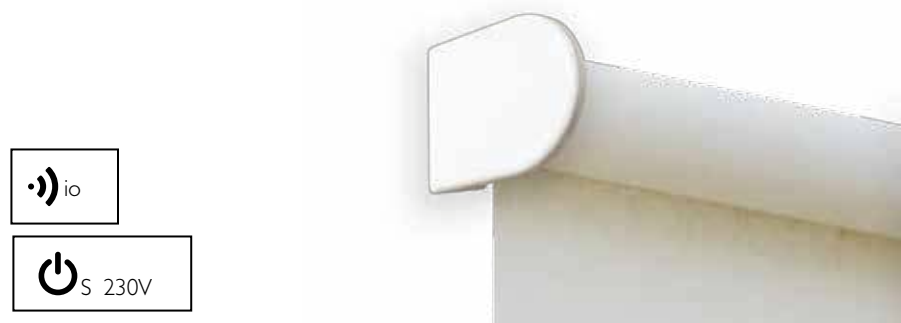

io  
S 230V

**PURE 47**  
objednávací kód  
**LRU47-MOTSIIOS**

**-B01** **-B04** **-B10** **-BRAL**

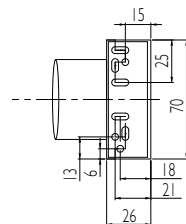
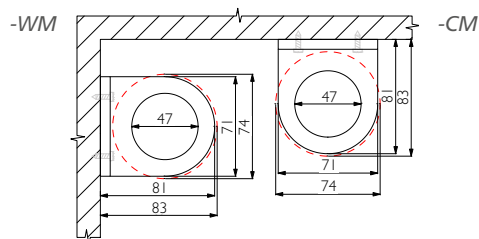
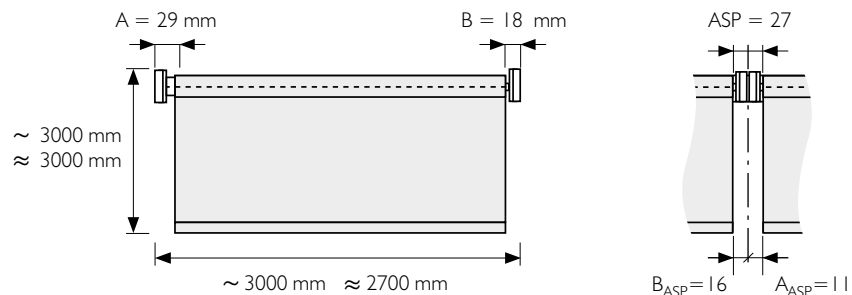

zátěžová lišta

sdrúžené rolety

motor iO

**-FINC25**

**-ASB..**

**-MOTSIIOS**

dálkový ovladač iO

**SITUO1W**



io  
MP  
S 230V

**PURE 47**  
product code  
**LRU47MP-MOTSIIOS**

**-B01** **-B04** **-B10** **-BRAL**

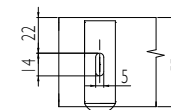
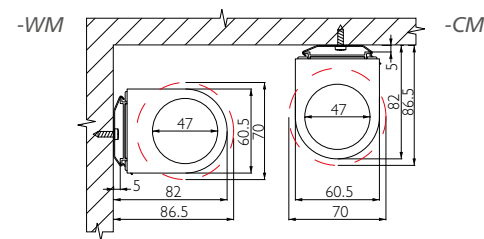
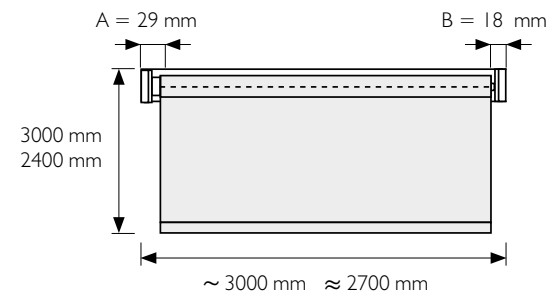

montážní profil

zátěžová lišta

motor iO

**-MP**

**-FINC25**

**-MOTSIIOS**

dálkový ovladač iO

**SITUO1W**

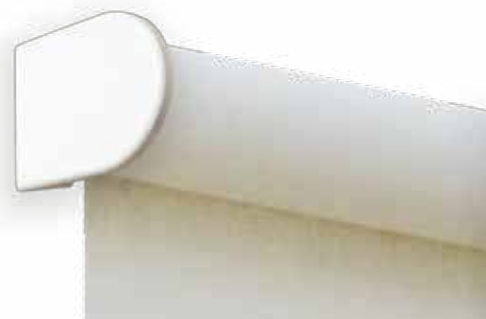
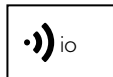

**PURE 54**  
objednávací kód  
**LRU54-MOTSIIOS**

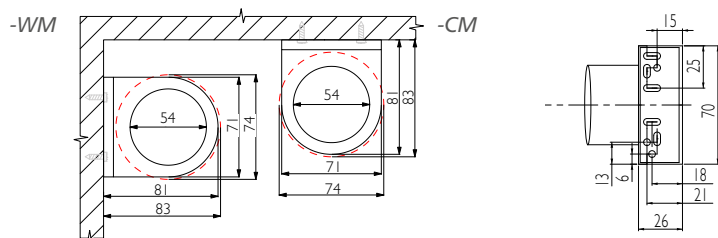
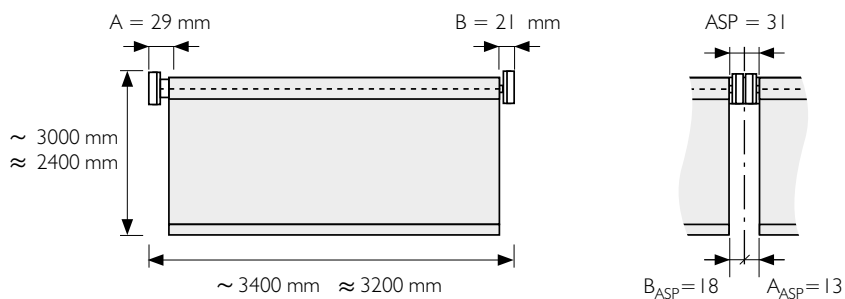
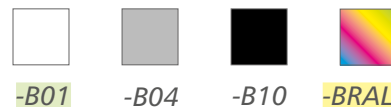

zátěžová lišta

sdrúžené rolety

motor iO

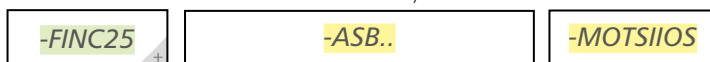

dálkový ovladač iO

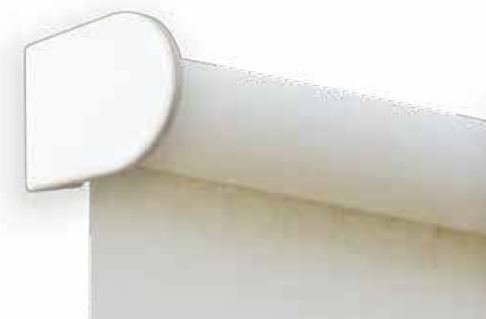
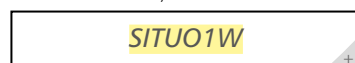

**PURE 47**  
objednávací kód  
**LRU47-MOTSIPA**

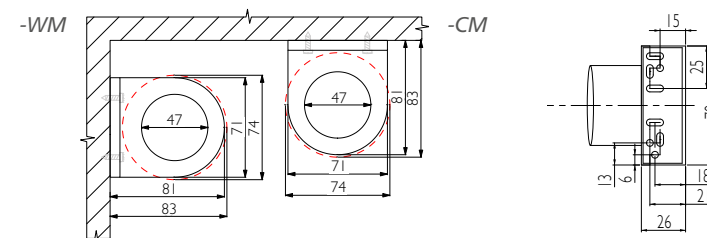
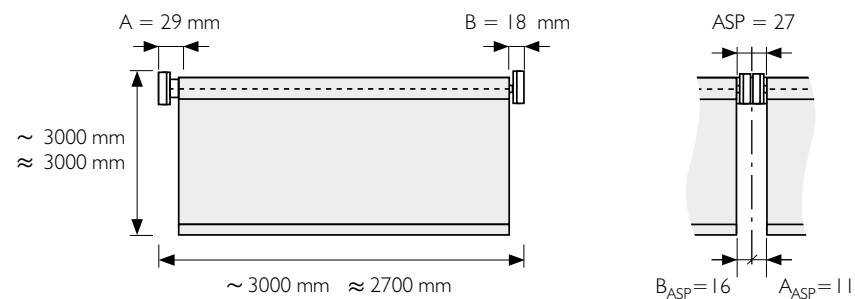

zátěžová lišta

sdrúžené rolety

motor PARALLEL

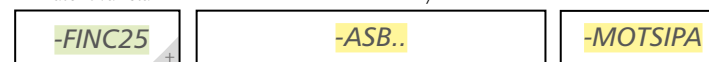



MP

 P 230V

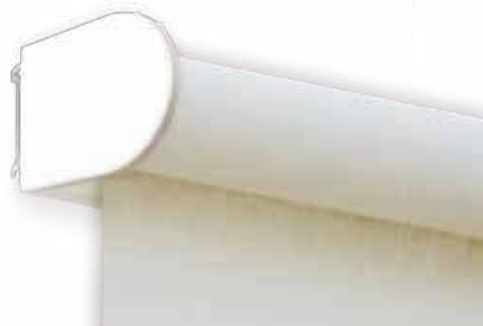

**PURE 47**  
product code  
**LRU47MP-MOTSIPA**

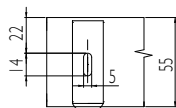
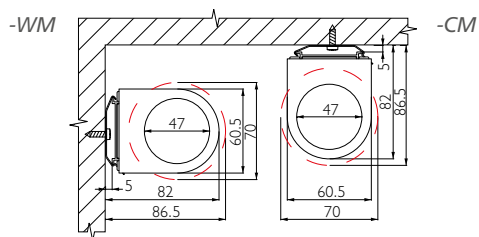
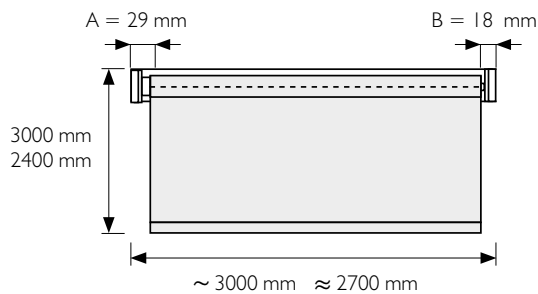
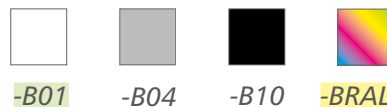

montážní profil      zátěžová lišta      motor PARALLEL

**-MP**      **-FINC25**      **-MOTSIPA**

 P 230V

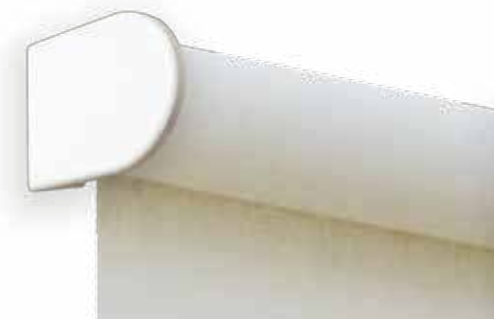

**PURE 54**  
objednávací kód  
**LRU54-MOTSIPA**

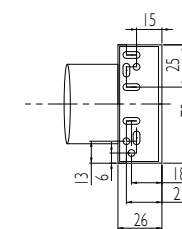
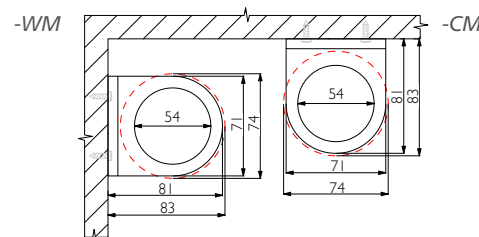
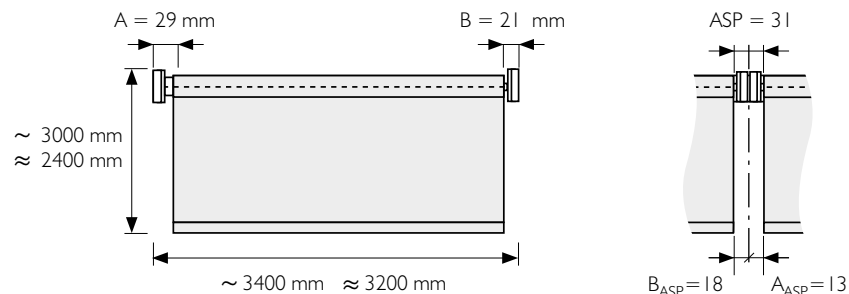
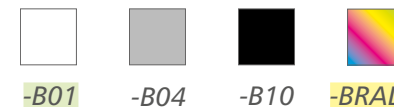

zátěžová lišta      sdrúžené rolety      motor PARALLEL

**-FINC25**      **-ASB..**      **-MOTSIPA**

BOX



# PURE 68R

objednací kód  
LRP68R-CH..



-B01



-B04



-BRAL

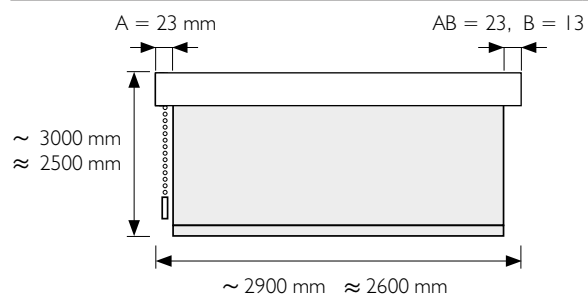

-WM

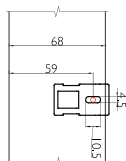

kazeta

68R

-CM

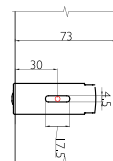

zátěžová lišta

-FINC25

kabel vpravo

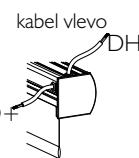
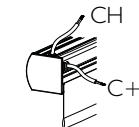

řetízek

-CHNI

závaží řetízku

-WE..



**PURE 68R**  
objednávací kód  
**LRP68R-MOT12RTA**

**-B01 -B04 -BRAL**

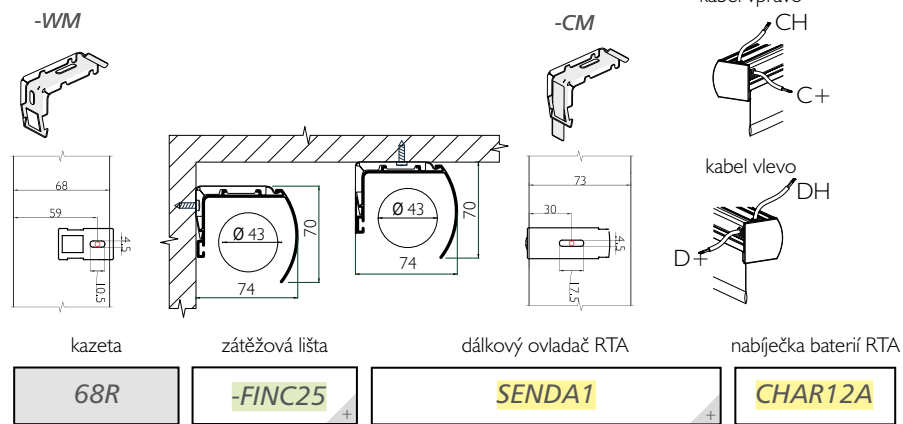
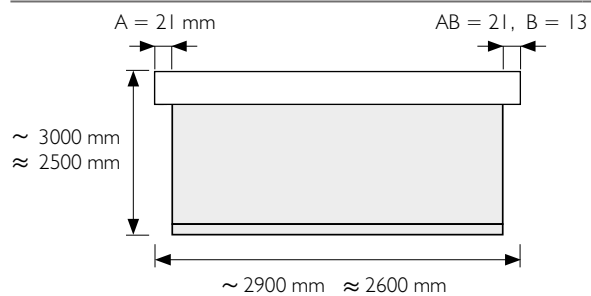

bateriový motor RTA      vývod kabelu

**MOT12RTA**    **-CEXIT**



**PURE 68R**  
objednávací kód  
**LRP68R-MOTSIA**

**-B01 -B04 -BRAL**

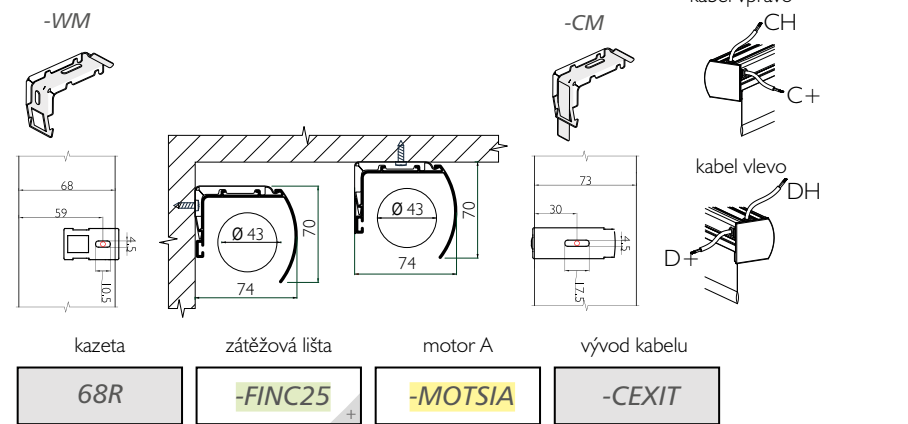
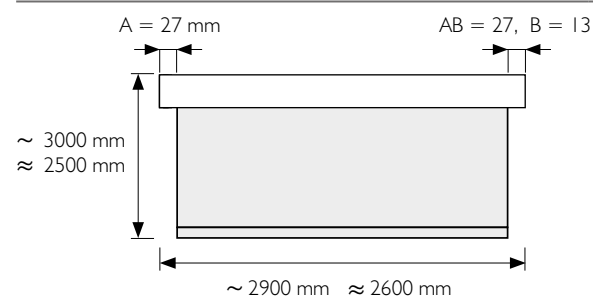

BOX

RTA

A 230V

**PURE 68R**

objednáací kód

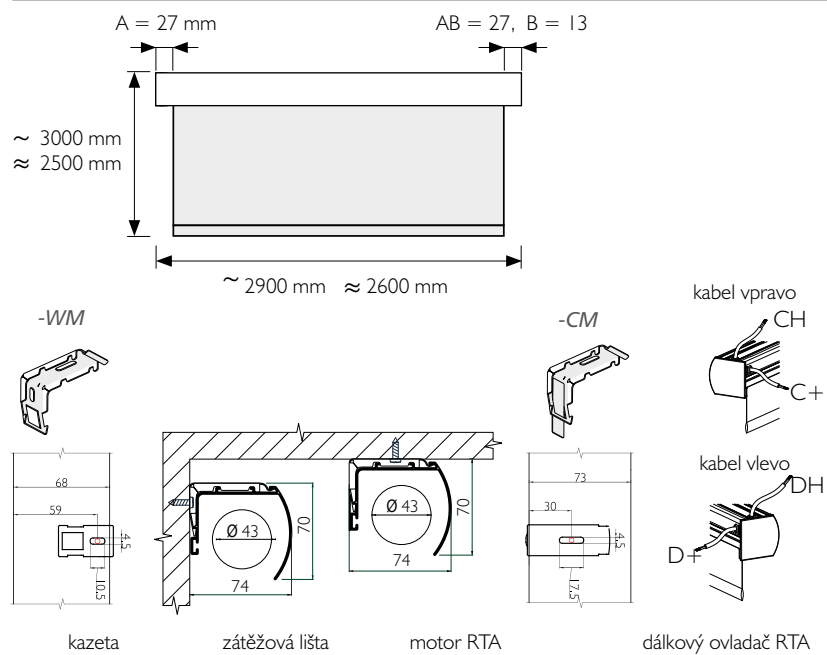
**LRP68R-MOTSIRTA****-B01****-B04****-BRAL**

kazeta

zátěžová lišta

motor RTA

dálkový ovladač RTA

**68R****-FINC25****-MOTSIRTA****SENDA1**

vývod kabelu

**-CEXIT**



BOX

RTS

Externí baterie

S baterie

**PURE 68R**  
objednací kód  
**LRP68R-MOT12IRTS**

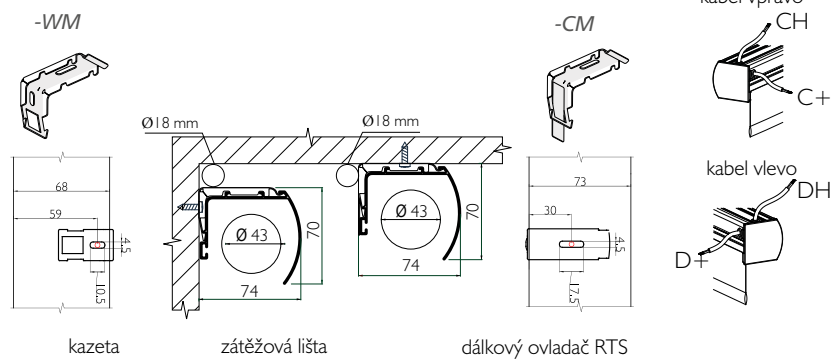
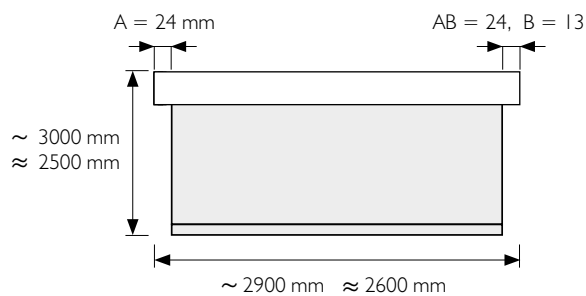

kazeta **68R** zátěžová lišta **-FINC25** dálkový ovladač RTS **TELIS1W**

sada dobíjecích baterií **BATTERY8SET** bateriový motor RTS **-MOT12IRTS** vývod kabelu **-CEXIT**



BOX

S 230V

**PURE 68R**  
objednací kód  
**LRP68R-MOTSIS**

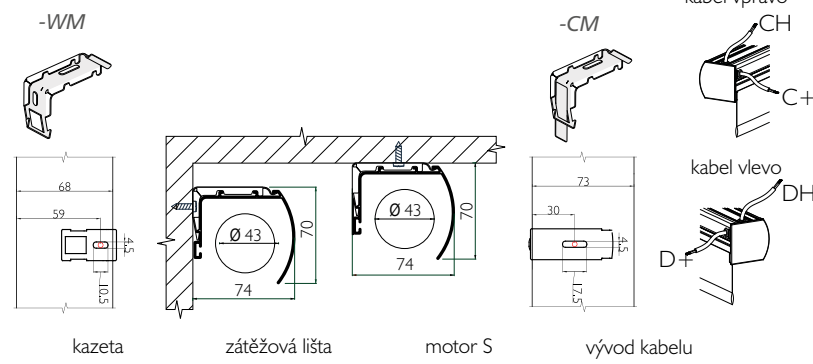
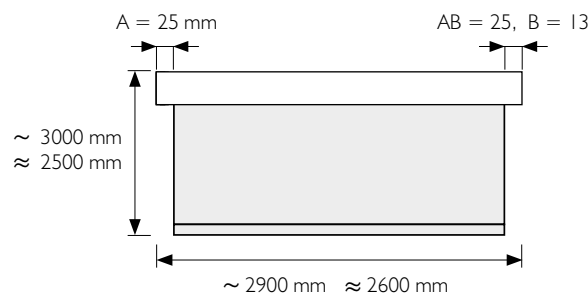

kazeta **68R** zátěžová lišta **-FINC25** motor S **-MOTSIS** vývod kabelu **-CEXIT**

sada dobíjecích baterií **BATTERY8SET** bateriový motor RTS **-MOT12IRTS** vývod kabelu **-CEXIT**

BOX

RTS

S



# PURE 68R

objednáací kód

LRP68R-MOTSIRTS



-B01



-B04



-BRAL

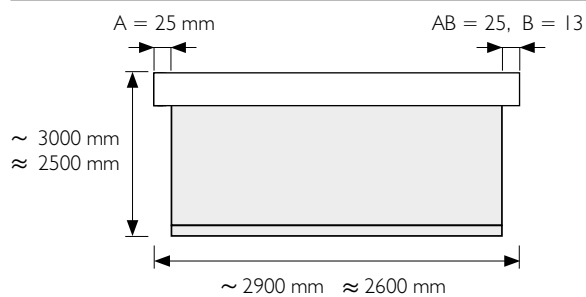

-WM

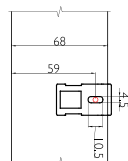

kazeta

-CM

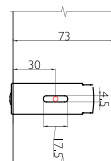

zátěžová lišta

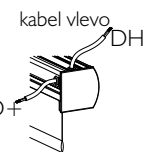
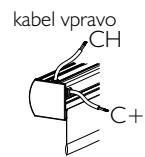

dálkový ovladač RTS

motor RTS

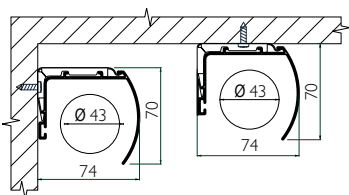

68R	-FINC25	-MOTSIRTS	TELIS1W
-----	---------	-----------	---------

vývod kabelu

-CEXIT

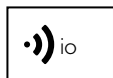

## PURE 68R

objednací kód  
LRP68R-MOTSIIOS



-B01 -B04 -BRAL

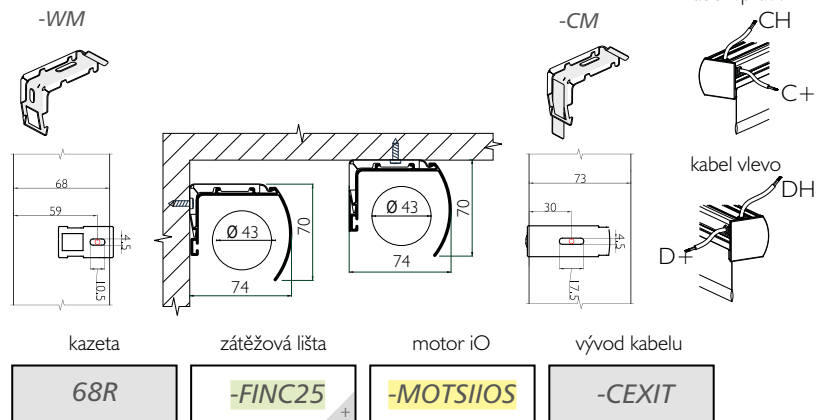
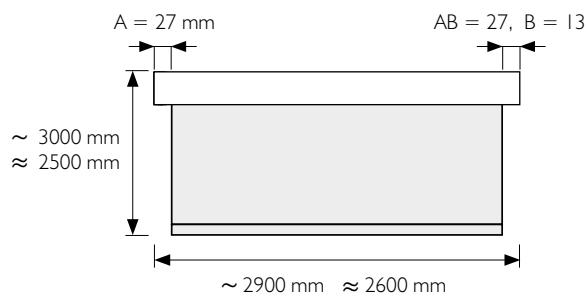

## PURE 68R

objednací kód  
LRP68R-MOTSIPA



-B01 -B04 -BRAL

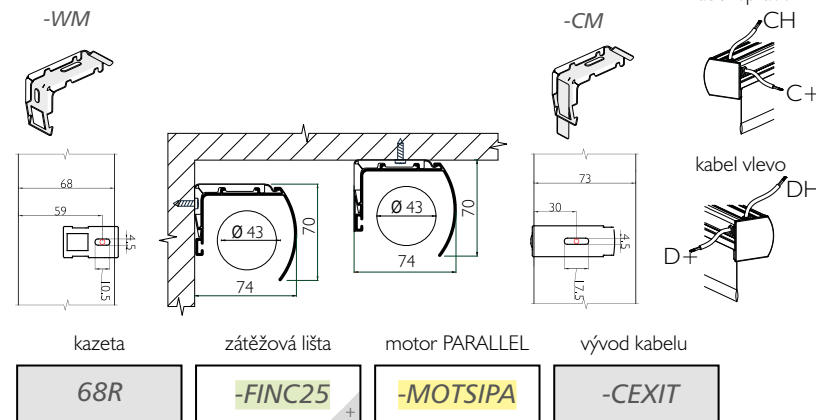
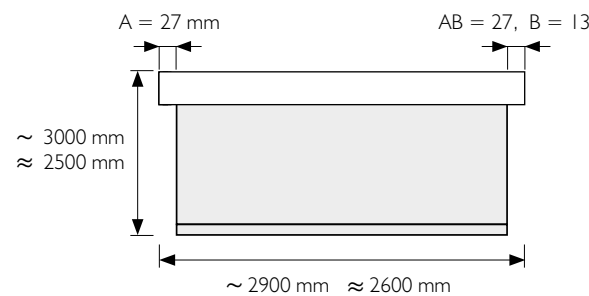

dálkový ovladač iO

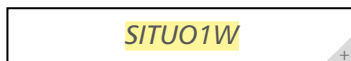

BOX



# PURE 86R

objednávací kód  
LRP86R-CH..



-B01



-B04



-BRAL

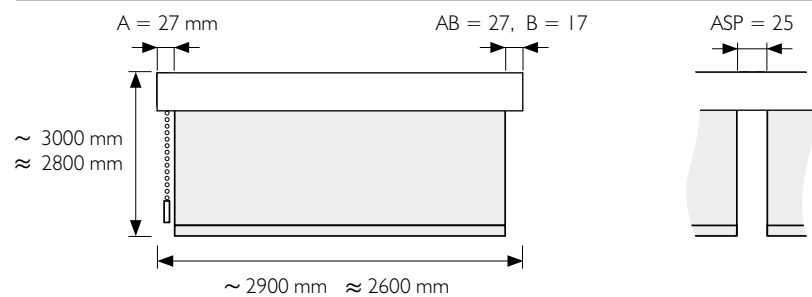

-WM

-CM

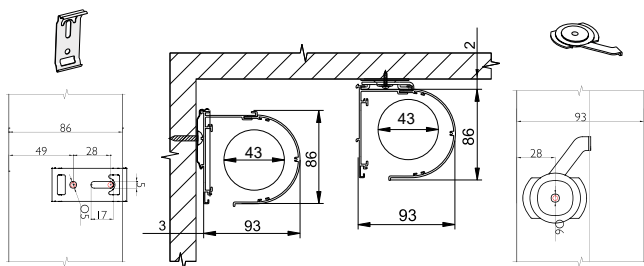

kazeta

zátěžová lišta

sdužené rolety

závaží řetízku

86R

-FINC25

-ASB..

-WE..

řetízek

vodící lanka

-CHNI

-CS..





## PURE 86R

objednací kód  
LRP86R-MOT12RTA

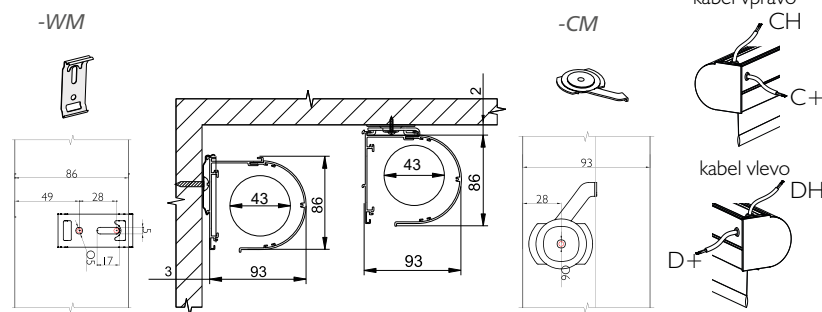
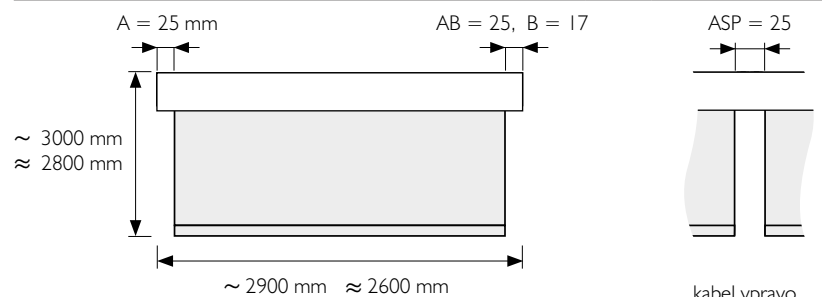

kazeta

zátěžová lišta

sdrúžené rolety

nabíječka baterií RTA

86R

-FINC25

-ASB..

CHAR12A

dálkový ovladač RTA

bateriový motor RTA

vývod kabelu

vodící lanka

SENDA1

-MOT12RTA

-CEXIT

-CS..



## PURE 86R

objednací kód  
LRP86R-MOTSIA

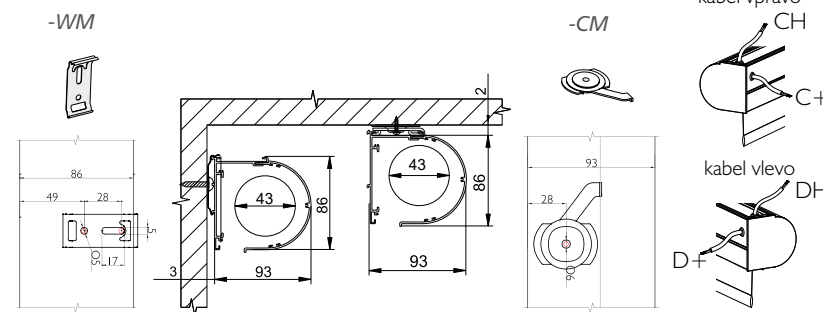
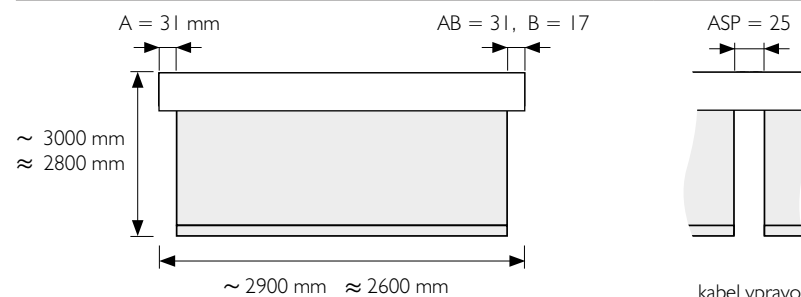

kazeta

zátěžová lišta

sdrúžené rolety

motor A

86R

-FINC25

-ASB..

-MOTSIA

vývod kabelu

vodící lanka

-CEXIT

-CS..

BOX

RTA

230V



# PURE 86R

objednávací kód  
LRP86R-MOTSIRTA



-B01



-B04



-BRAL

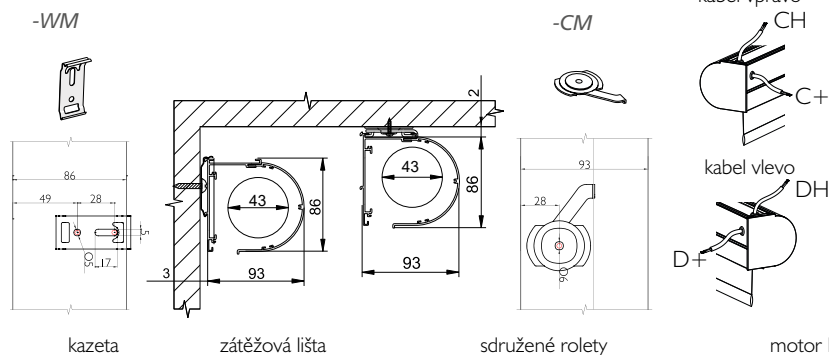
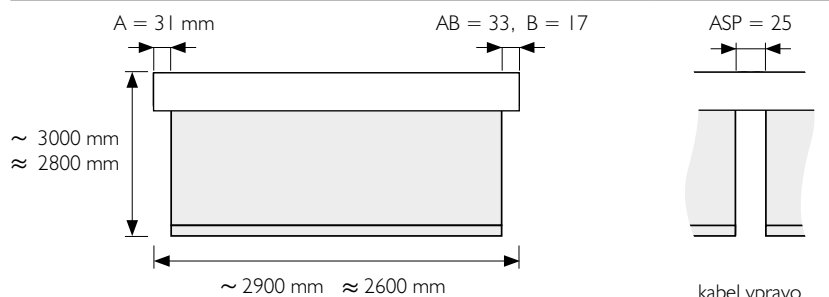

86R -FINC25 -ASB.. -MOTSIRTA

dálkový ovladač RTA SENDA1 vývod kabelu -CEXIT vodící lanka -CS..



BOX

RTS

Externí baterie

S baterie

## PURE 86R

objednávací kód

LRP86R-MOT12IRTS



-B01 -B04 -BRAL

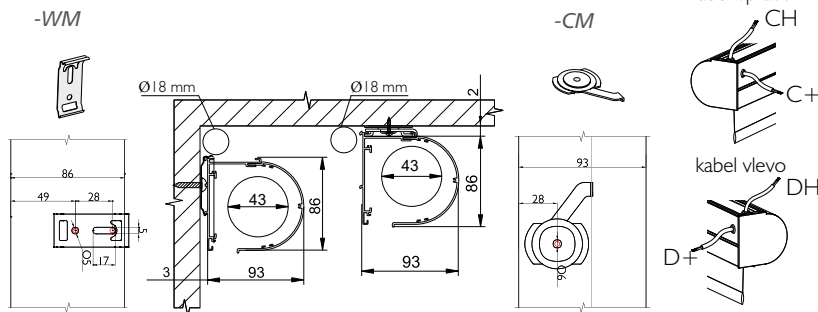
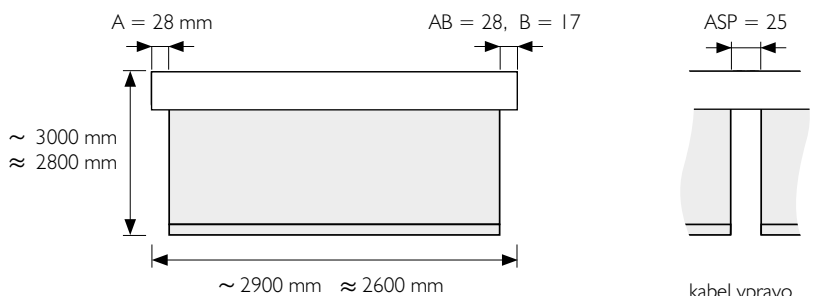

kazeta	zátěžová lišta	sdužené rolety	bateriový motor RTS
86R	-FINC25	-ASB..	-MOT12IRTS

sada baterií	dálkový ovladač RTS	vývod kabelu	vodící lanka
BATTERY8SET	TELIS1W	-CEXIT	-CS..



BOX

S 230V

## PURE 86R

objednávací kód

LRP86R-MOTSIS



-B01 -B04 -BRAL

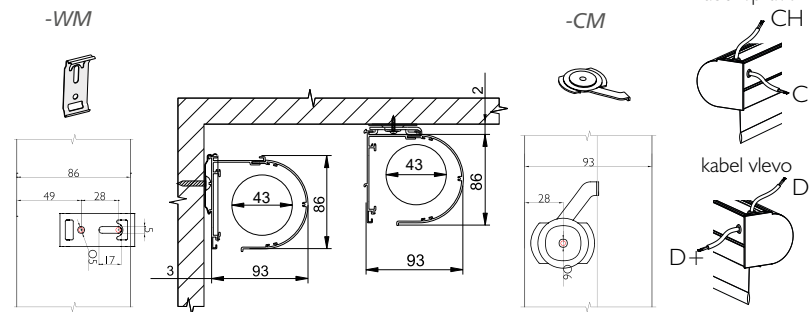
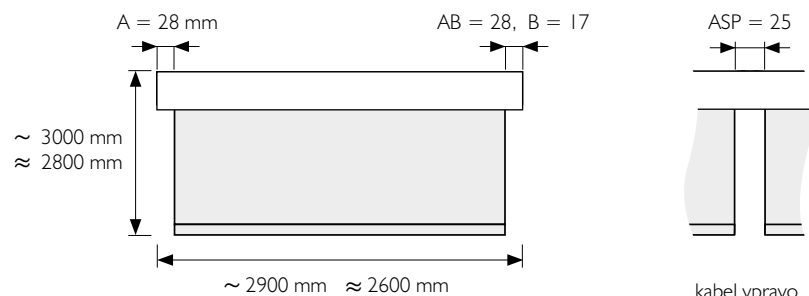

kazeta	zátěžová lišta	sdužené rolety	motor S
86R	-FINC25	-ASB..	-MOTSIS

vývod kabelu	vodící lanka
-CEXIT	-CS..

BOX

RTS

230V



# PURE 86R

objednávací kód

LRP86R-MOTSIRTS



-B01

-B04

-BRAL

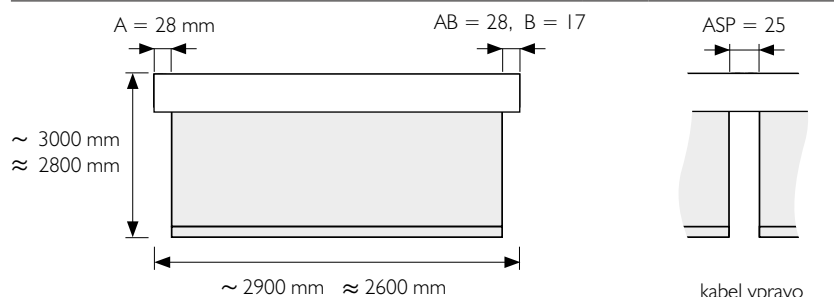

-WM

-CM

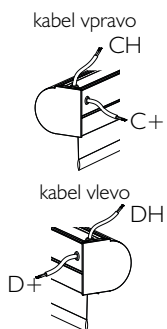
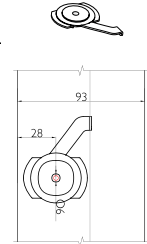
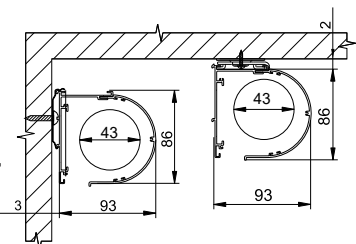
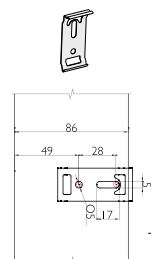

kazeta

zátěžová lišta

sdrúžené rolety

motor RTS

86R

-FINC25

-ASB..

-MOTSIRTS

dálkový ovladač RTS

vývod kabelu

vodící lanka

TELIS1W

-CEXIT

-CS..

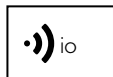

### PURE 86R

objednávací kód  
LRP86R-MOTSIIOS



**-B01** **-B04** **-BRAL**

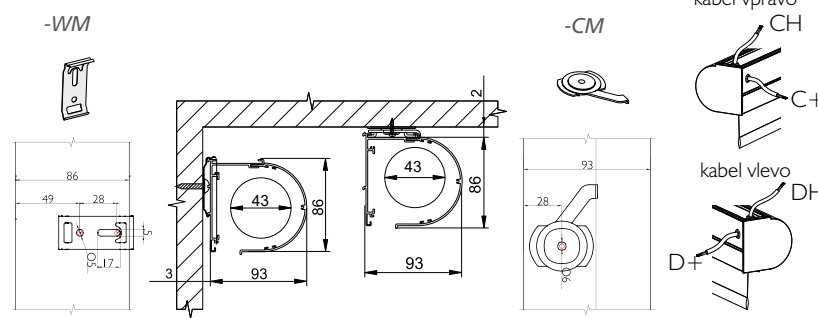
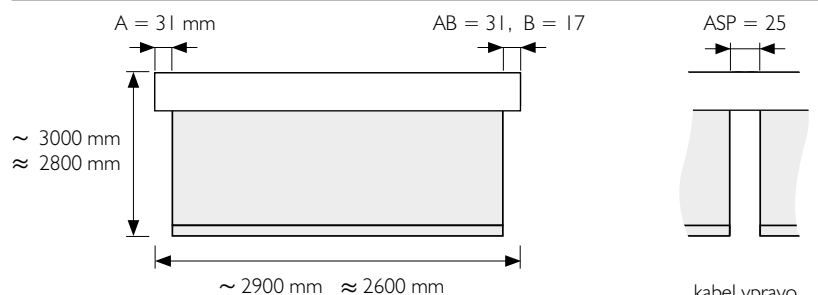

kazeta	zátěžová lišta	sdrúžené rolety	motor iO
86R	-FINC25	-ASB..	-MOTSIIOS

dálkový ovladač iO	vývod kabelu	vodící lanka
SITUO1W	-CEXIT	-CS..



### PURE 86R

objednávací kód  
LRP86R-MOTSIPA



**-B01** **-B04** **-BRAL**

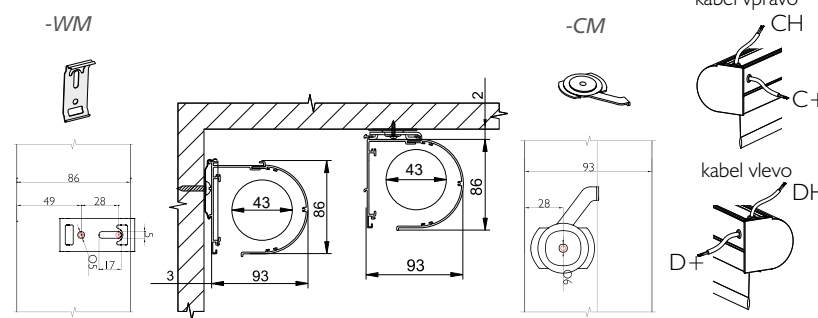
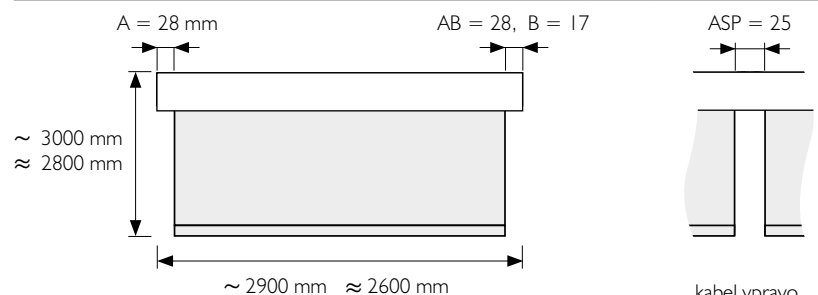

kazeta	zátěžová lišta	sdrúžené rolety	motor PARALLEL
86R	-FINC25	-ASB..	-MOTSIPA

vývod kabelu	vodící lanka
-CEXIT	-CS..

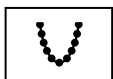

# PURE 86S

objednávací kód  
LRP86S-CH..



-B01



-B04



-BRAL

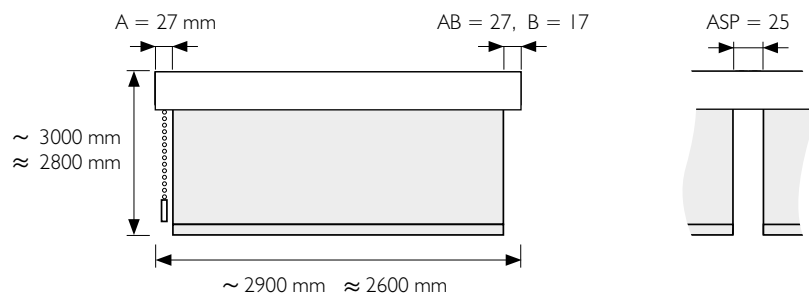

-WM

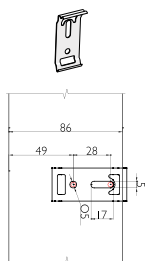

kazeta

86S

-CM

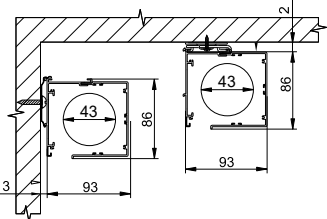

zátěžová lišta

-FINC25

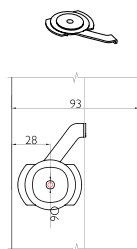

sdužené rolety

-ASB..

závaží řetízku

-WE..

řetízek

-CHNI

vodící lanka

-CS..



## PURE 86S

objednací kód  
LRP86S-MOT12RTA



-B01 -B04 -BRAL

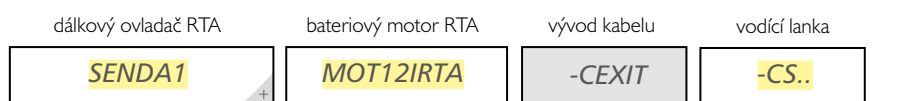
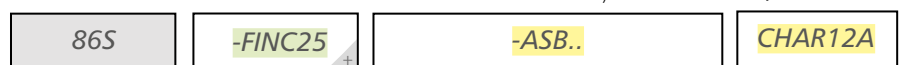
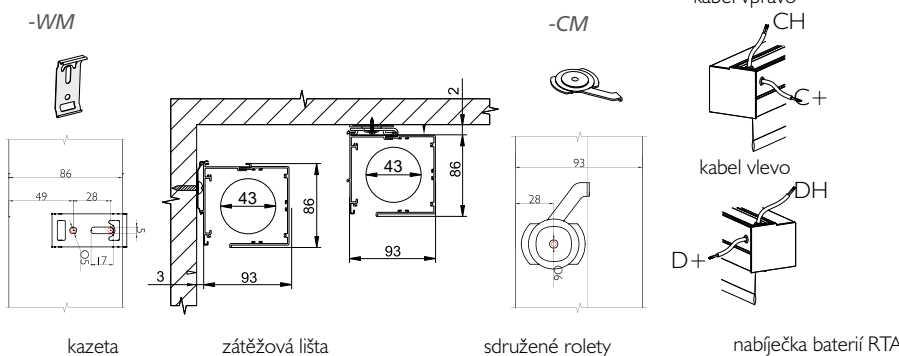
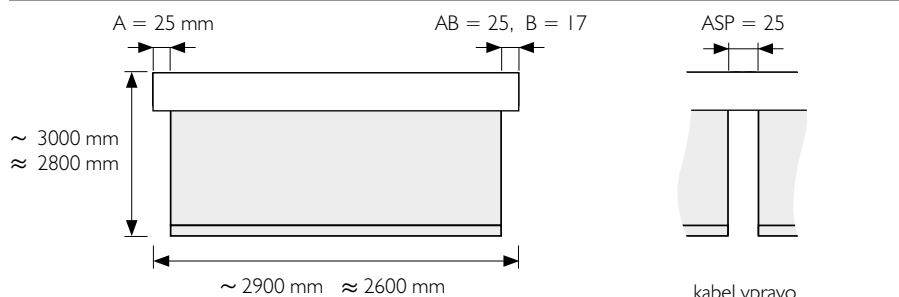

## PURE 86S

objednací kód  
LRP86S-MOTSIA



-B01 -B04 -BRAL

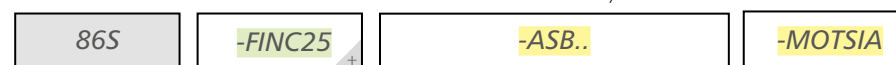
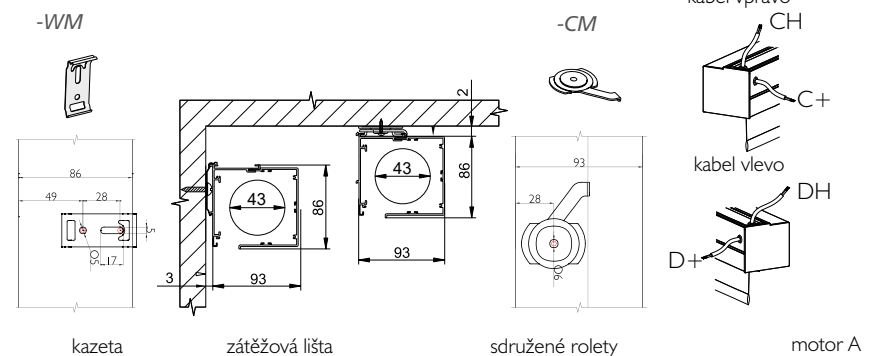
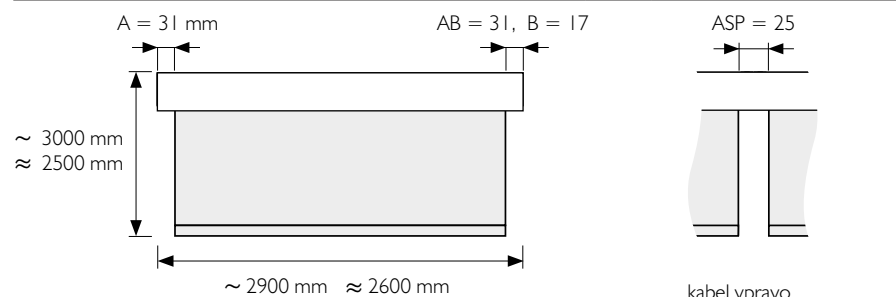

BOX

·)) RTA

⏻ A 230V



# PURE 86S

objednávací kód  
LRP86S-MOTSIRTA



-B01



-B04



-BRAL

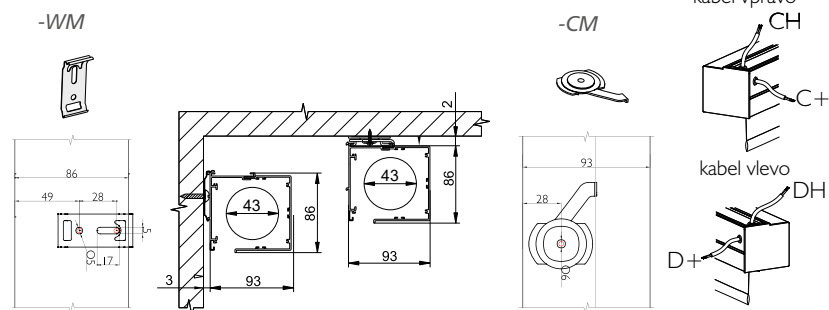
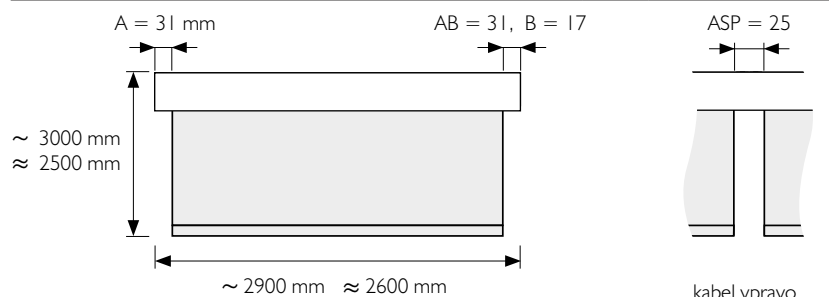

kazeta	zátěžová lišta	sružené rolety	motor RTA
86S	-FINC25	-ASB..	-MOTSIRTA

dálkový ovladač RTA	vývod kabelu	vodící lanka
SENDA1	-CEXIT	-CS..





**PURE 86S**  
objednávací kód  
**LRP86S-MOT12IRTS**

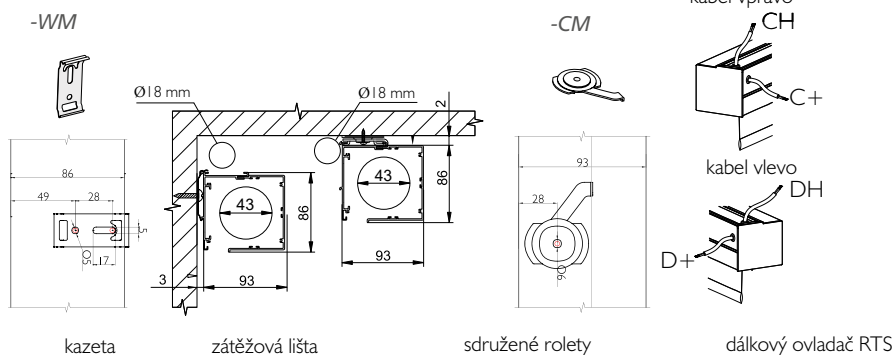
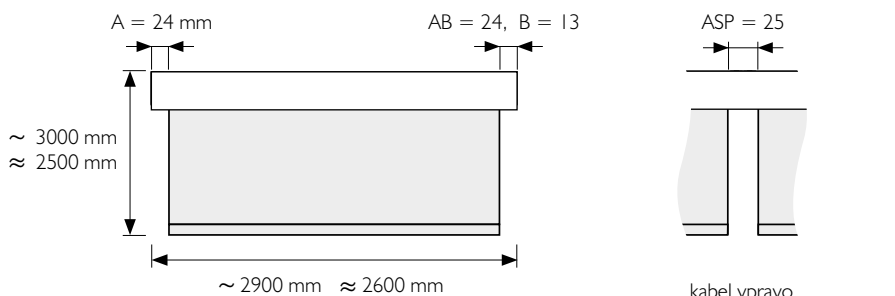

kazeta 86S      zátěžová lišta -FINC25      sdrúžené rolety -ASB..      dálkový ovladač RTS TELIS1W

sada baterií BATTERY8SET      bateriový motor RTS MOT12IRTS      vývod kabelu -CEXIT      vodící lanka -CS..



**PURE 86S**  
objednávací kód  
**LRP86S-MOTSIS**

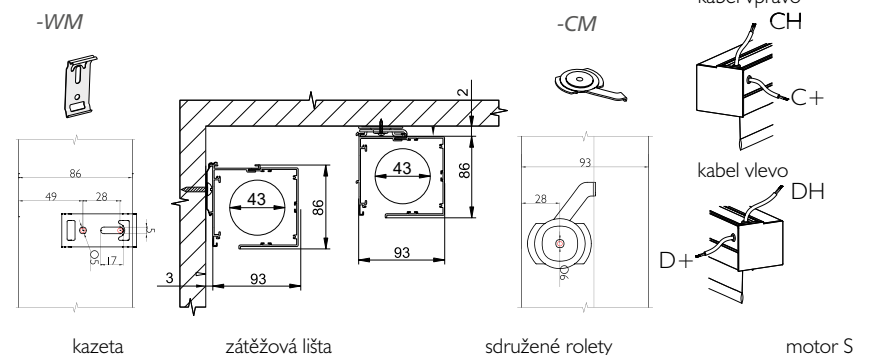
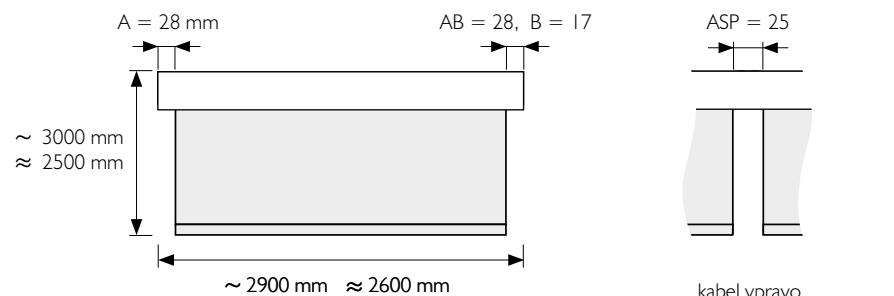

kazeta 86S      zátěžová lišta -FINC25      sdrúžené rolety -ASB..      motor S -MOTSIS

vývod kabelu -CEXIT      vodící lanka -CS..

BOX

RTS

230V



# PURE 86S

objednací kód  
LRP86S-MOTSIRTS

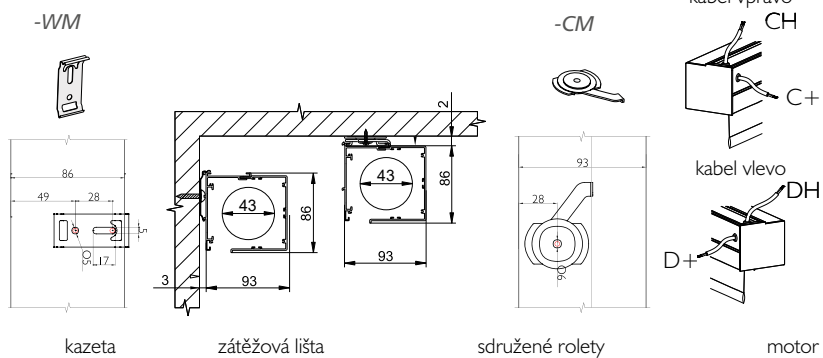
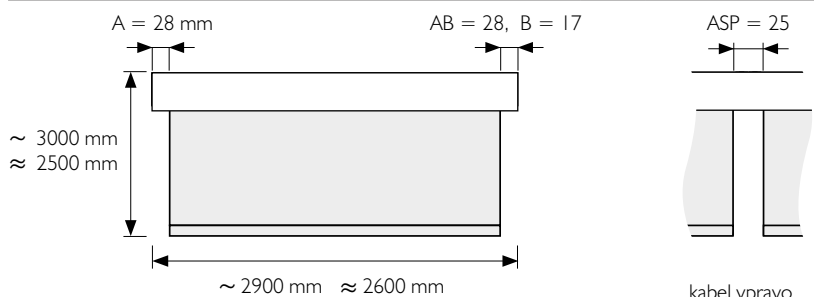

86S    -FINC25    -ASB..    -MOTSIRTS

dálkový ovladač RTS    vývod kabelu    vodící lanka

TELIS1W    -CEXIT    -CS..

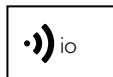

## PURE 86S

objednávací kód  
LRP86S-MOTSIIOS



**-B01** **-B04** **-BRAL**

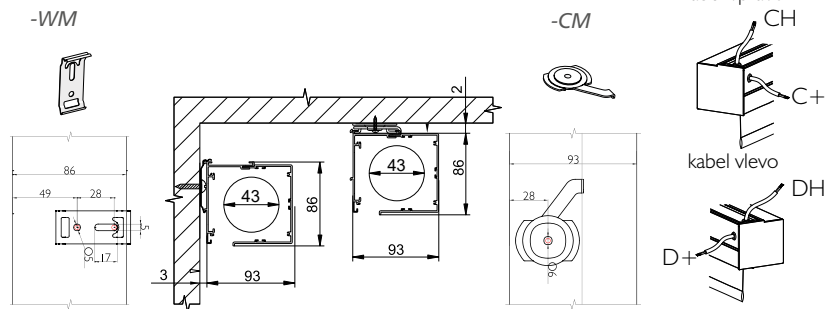
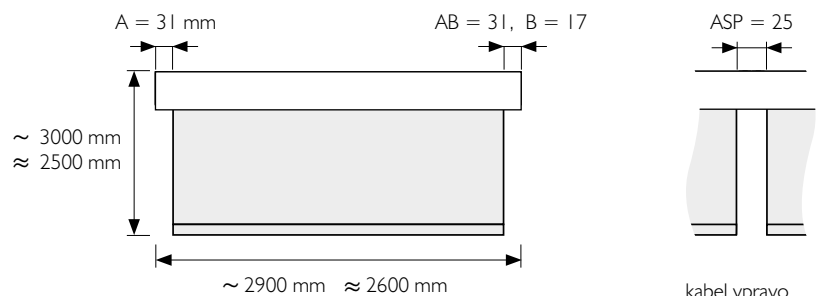

kazeta	zátěžová lišta	sdrúžené rolety	motor iO
86S	-FINC25	-ASB..	-MOTSIIOS

iO remote control	vývod kabelu	vývod kabelu
SITUO1W	-CEXIT	-CS..



## PURE 86S

objednávací kód  
LRP86S-MOTSIPA



**-B01** **-B04** **-BRAL**

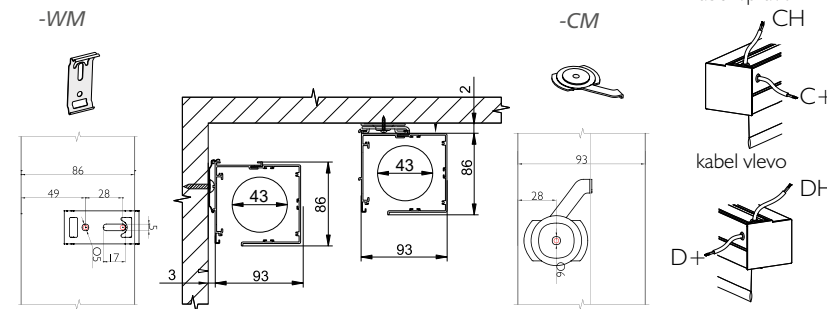
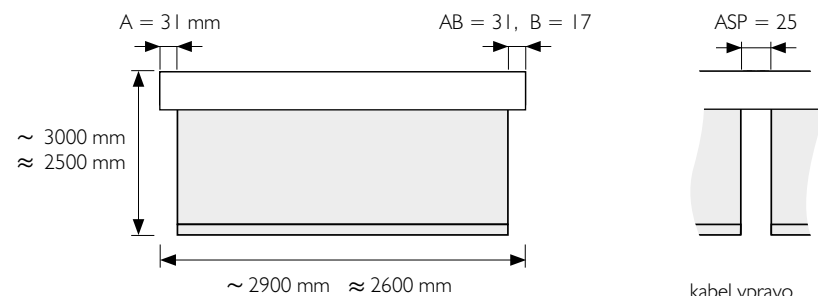

kazeta	zátěžová lišta	sdrúžené rolety	motor PARALLEL
86S	-FINC25	-ASB..	-MOTSIPA

vývod kabelu	vývod kabelu
-CEXIT	-CS..

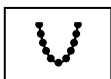

**WING**  
product code  
**LRP34WIN-CH01**

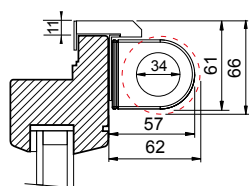
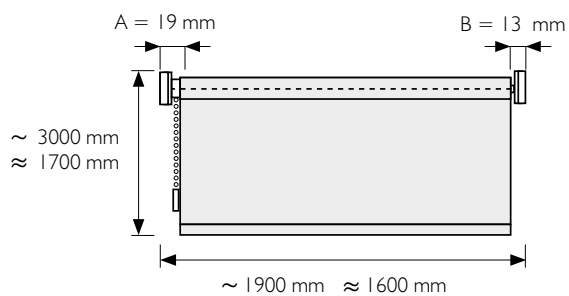

montážní profil

zátěžová lišta

závaží řetízku

řetízek

vodící lanka

**WIN**

**-FINBVL**

**-WE..**

**-CH01**

**-CS..**



**PURE 40**  
objednávací kód  
**LRP34WIN-MOT12RTA**

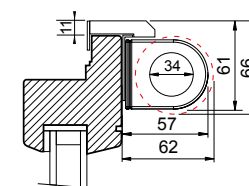
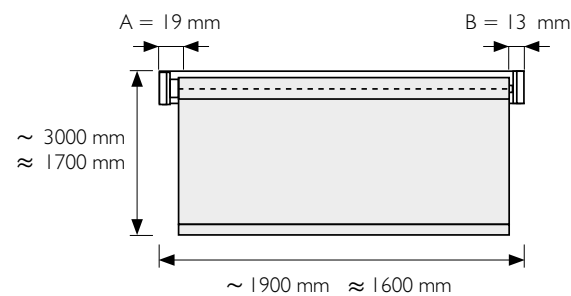

montážní profil

zátěžová lišta

dálkový ovladač RTA

nabíječka baterií

**-MP**

**-FINC25**

**SENDA1**

**CHAR12A**

bateriový motor RTA

**-MOT12RTA**

MP

RTS

Externí baterie

S baterie



**PURE 40**

objednávací kód

**LRP34WIN-MOT12IRTS**



**-B01**

**-BRAL**

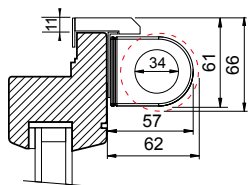
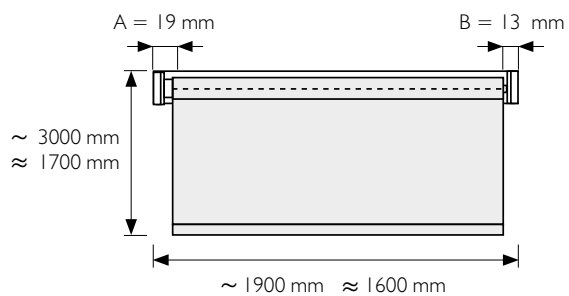

montážní profil

zátěžová lišta

dálkový ovladač RTS

**-MP**

**-FINC25**

**TELIS1W**

sada dobíjecích baterií

bateriový motor RTS

**BATTERY8SET**

**MOT12IRTS**

## Spodní zátěžová lišta

Objednací  
kód  
-FIN..

type B  
-FINB



type C  
-FINC

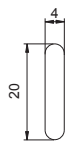

type C 25  
-FINC25



type M  
-FINM

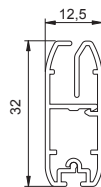

type D  
-FIND..



type E  
-FINE..

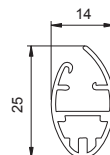

type M2  
-FINM2

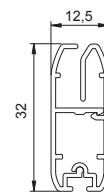

type F  
-FINF..

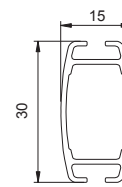

type J 30  
-FINJ30ANA



type W 50  
-FINW50..



- bílá
- černá
- šedá

-FINM01

- bílá
- šedá/elox
- černá
- RAL..
- RAL

-FIND01

- bílá
- šedá/elox
- černá
- RAL..
- RAL

-FINE01

- bílá
- šedá/elox
- černá
- RAL..
- RAL

-FINM201

- bílá
- šedá/elox
- černá

-FINF01

- bílá

Eloxovaný hliník

- FINW50 S01
- FINW50 H03
- FINW50 E03
- FINW50 Y08
- FINW50 P08

## Designové provedení konzol PURE WOOD

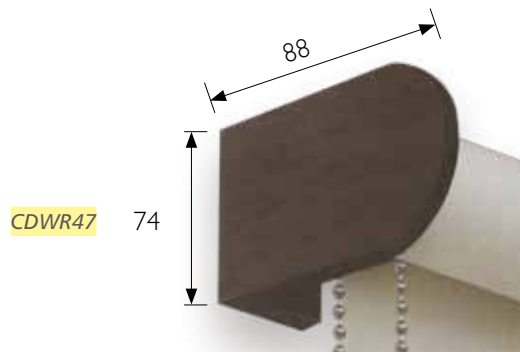
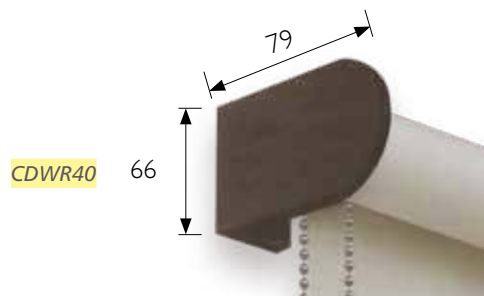
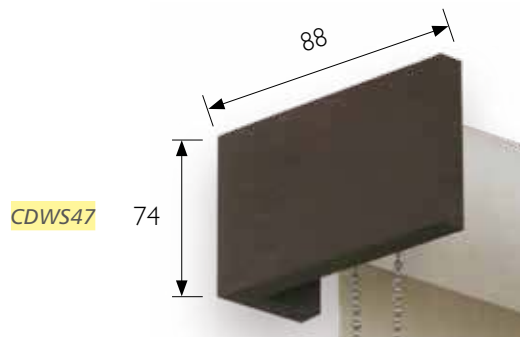
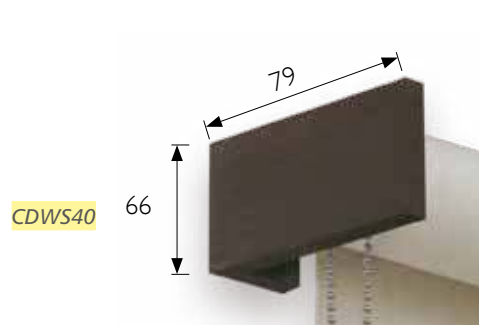

SELENE S01



HARMONIA H03



ENARETE E03



RHEIA R08

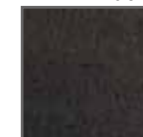

PERSES P08

## Garnýž PURE WOOD

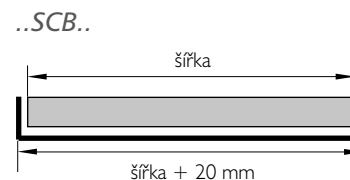
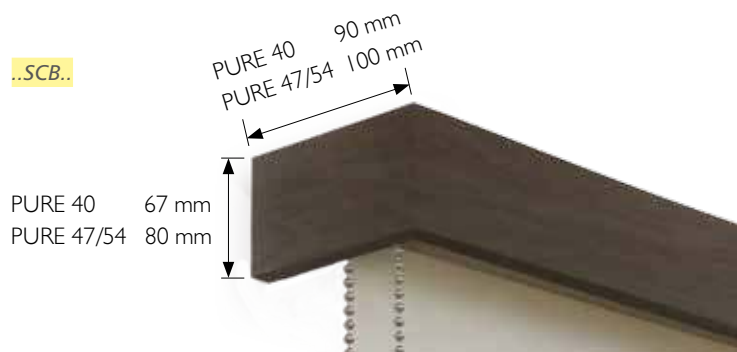

## Nekonečný řetízek

Ovládání řetízem musí být v souladu s normou EN 13120-Ochrana proti nebezpečí uškrcení. Dodaná výška ovládání a event. dodané bezpečnostní prvky jí budou odpovídat.

Objednací  
kód  
-CH..

bílá  
-CH01

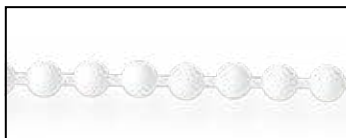

šedá  
-CH04

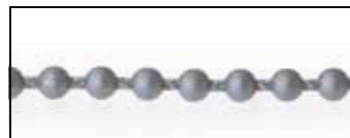

černá  
-CH10



nikl satén  
-CHNI



bronz  
-CHBR

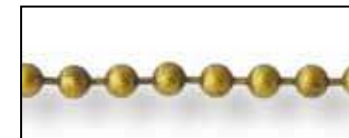

Gun metal  
-CHGM

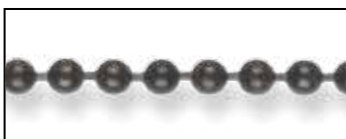

Dungeon  
-CHDU



Medieval brass  
-CHMB

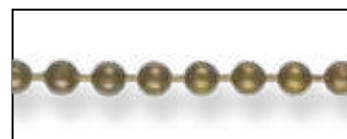

Mystic red  
-CHMR

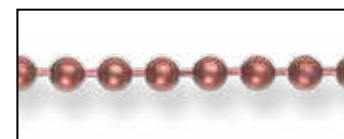

## Bezpečnostní prvky

Rozpojitelný řetízkový adaptér.  
Bílá barva  
-CHSA01

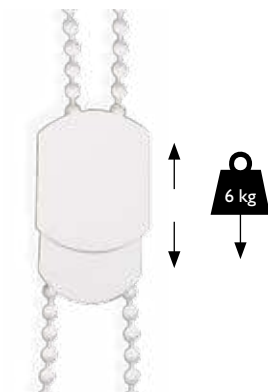

Rozpojitelný řetízek.  
Transparentní spojka  
-CHSCTR



### ! BEZPEČNOSTNÍ UPOZORNĚNÍ



Nebezpeční uškrcení malých dětí ve smyčce ovládacího řetízku nebo šňůry. Nenechávejte děti bez dozoru blízko ovládacího řetízku nebo šňůry.





## Závaží typ 2

rozměr A = 66 mm, B = 45 mm

Objednací  
kód  
-WE..

bílá  
-WE201

šedá  
-WE204

černá  
-WE210

transparentní  
-WE2TR

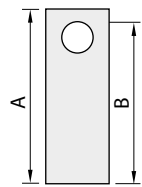

rozměr závaží



## Vodící lanka

product code  
-CS..

Obyč. roletu  
PURE 47CHa  
Mot



Příklady použití:

LRP86R-CH..

LRP86R-MOT..

## Odpočet látky

Pro rolety s vodícím lankem, je vždy stejný odpočet látky na obou stranách (B=A).

## Vodící lanko nerezové 1 mm

### Zátěžová lišta

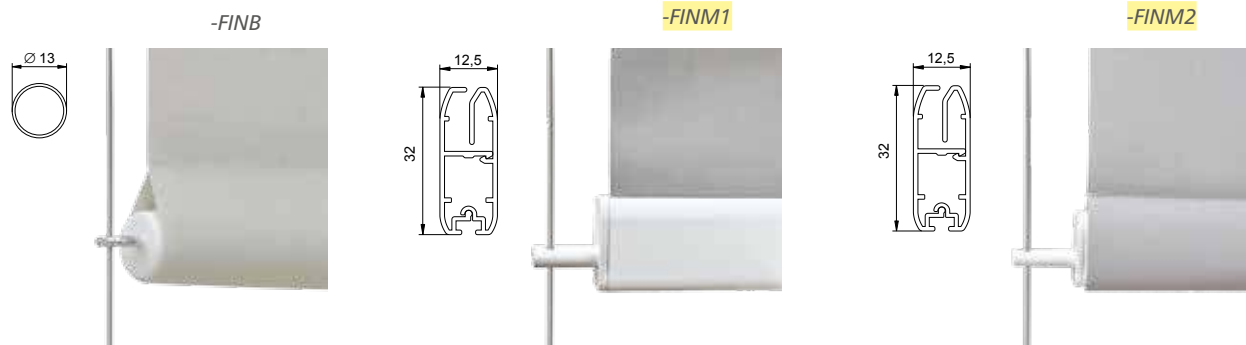

spodní uchycení stěna  
16 x 16 x 32 mm  
-CSEWMP



spodní uchycení podlaha  
16 x 16 x 21 mm  
-CSEF

## Sdružené rolety - společné ovládání

- sdružující mechanismus pro dvě nebo tři rolety
- jedno ovládání pro skupinu rolet (rolety jdou nahoru i dolů společně)
- maximálně 3 rolety na jedno ovládání

Pozor při objednání. Spojovací konzole není ASP/2, odpočty látek se řídí dle schématu u každého modelu.

Příklad LRU40-CH.. :

A 23 mm      B<sub>ASP</sub> 16 mm    A<sub>ASP</sub> 11 mm      B<sub>APS</sub> 16 mm    A<sub>ASP</sub> 11 mm      B 18 mm

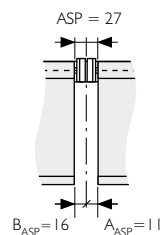

**-ASB1**

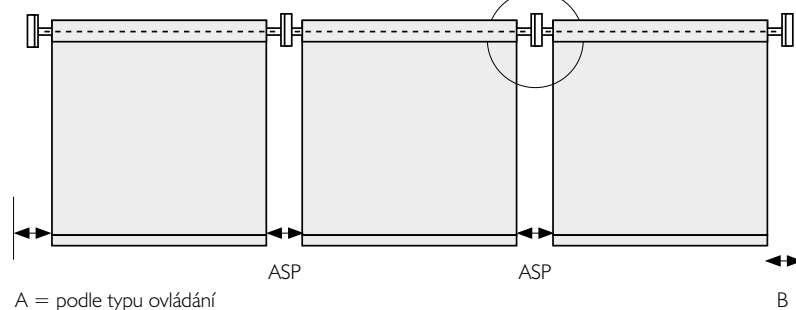

**Skupinové ovládání rolet pod úhlem 0–45°, rolety bez boxu**  
pouze Pure 47  
**-ASB2**

Pro speciální řešení kontaktujte naše specialisty.

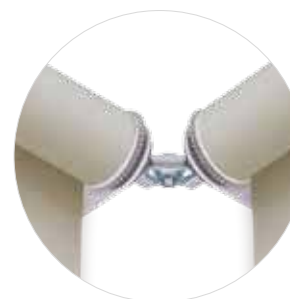

**Skupinové ovládání rolet pod úhlem 0–90°, bez kazety**  
pouze Pure 47  
**-ASB3**

Pro speciální řešení kontaktujte naše specialisty.

**-ASB1BX**

Skupinové ovládání s boxem PURE86R a PURE86S

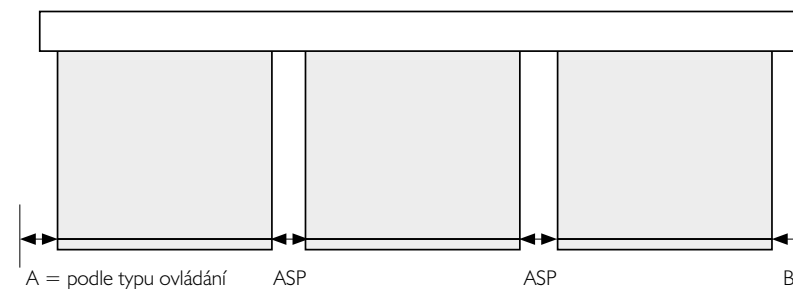

## Kazeta - samostatné ovládání

Obj. kód  
-ASB..

- slouží ke spojení rolet na společný montážní prvek
- estetické důvody, rychlejší a pohodlnější montáž
- každá roleta je ovládaná samostatně
- nelze použít kovové konzoly
- Max. šířka montážního profilu **5980 mm**

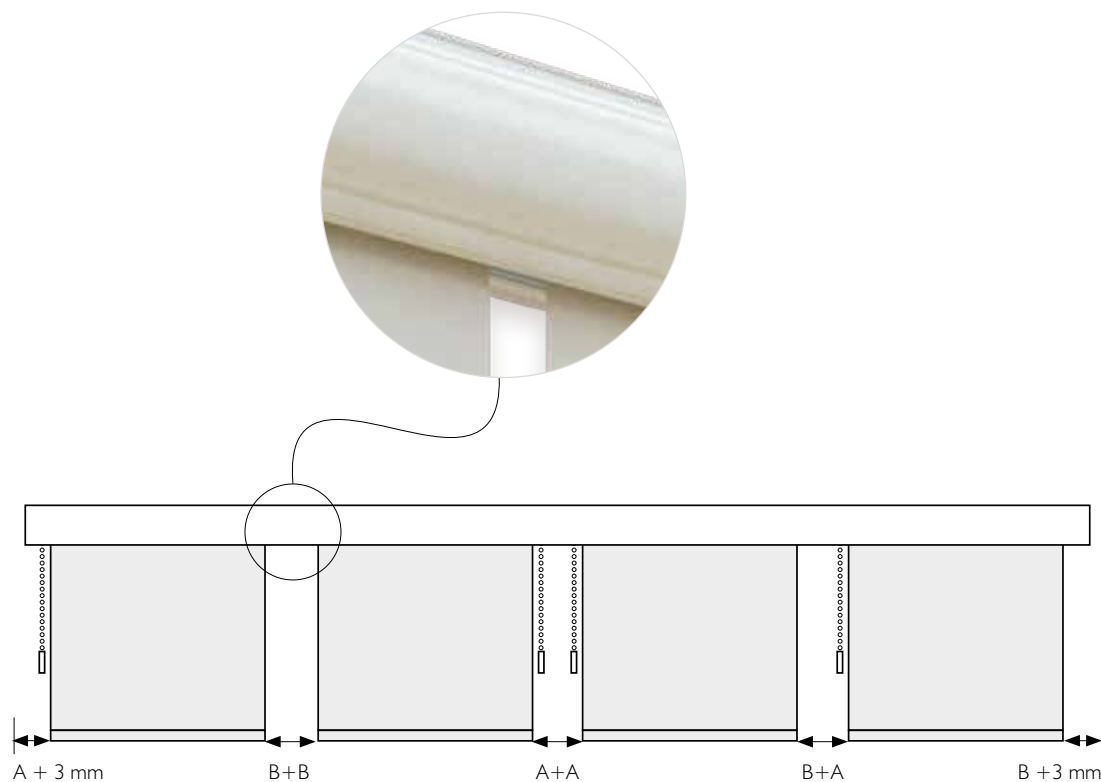

*i*

- Při volbě sdružení rolet zvažte přepravní možnosti a manipulační prostor v místě montáže (výtah, rozměry chodby apod.)
- Spodní lišty nemusí být v rovině (tolerance 5 mm)

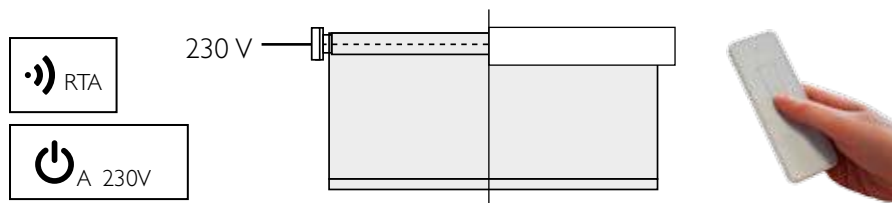

## Tichý motor RTA pro bezdrátové ovládání

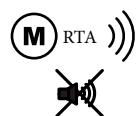

### Silent Motor RTA

S integrovaným přijímačem, kabel délky 1 m

**-MOTSIRTA**

## + dálkový ovladač RTA



1 kanálový vysílač, SendA 1  
**SENDA1**



6 kanálový vysílač, SendA 6  
Pro motory s dálkovým ovladačem RTA. Bílá barva.  
**SENDA6**

Mechanicky nastavitelné koncové polohy na hlavě motoru bez možnosti nastavení mezipolohy.

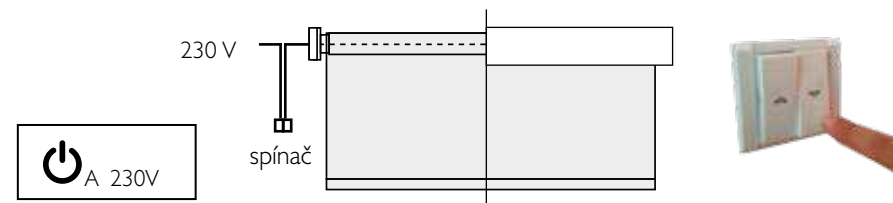
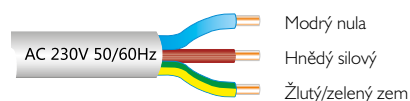

## Tichý motor A pro drátové ovládání



### Silent motor A

Délka kabelu 1 m

**-MOTSIA**

## + Ovládání



Switch Time®  
**SWTIME**

Mechanicky nastavitelné koncové polohy na hlavě motoru bez možnosti nastavení mezipolohy.



Nikdy nezapojujte více motorů na jeden spínač bez užití relé.



**-PROGRAM** uživatelské naprogramování: Na přání zákazníka jsou pozice ovladače nastaveny dle požadovaných instrukcí (kanál – výrobek, párování atd.).

U motorů bez možnosti nastavení mezipolohy, není možné garantovat stejnou polohu rolet mezi koncovými polohami.

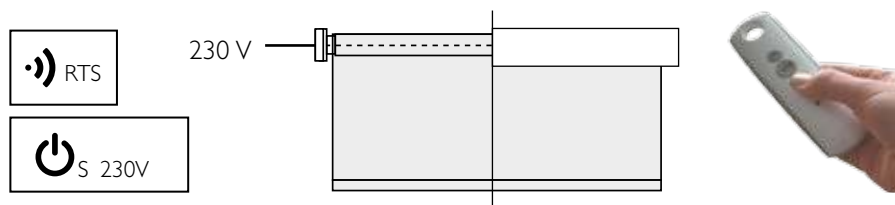

## Motor RTS pro bezdrátové ovládání



**motor RTS**  
S integrovaným přijímačem, délka kabelu 3 m  
**-MOTRTS**

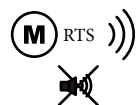

**tichý motor RTS**  
S integrovaným přijímačem, délka kabelu 3 m  
**-MOTSIRTS**

## + dálkový ovladač RTS



**1 kanálový vysílač, Telis 1**  
**TELIS1W**



**5 kanálový vysílač, Telis 4**  
Po motory Somfy s dálkovým ovladačem RTS. Barva bílá.  
**TELIS5W**



**1 kanálový ovladač nástěnný Smoove Origin**  
**ORIGIN**

Elektronické nastavení s možností mezipolohy.



**-PROGRAM** uživatelské naprogramování: Na přání zákazníka jsou pozice ovladače nastaveny dle požadovaných instrukcí (kanál – výrobek, párování atd.).

U motorů bez možnosti nastavení mezipolohy, není možné garantovat stejnou polohu rolet mezi koncovými polohami.

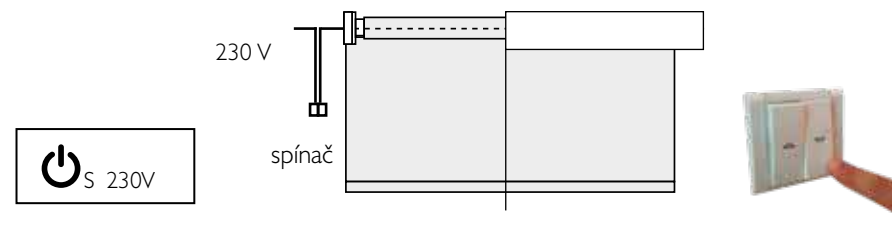

## motor S pro drátové ovládání



**motor S**  
Délka kabelu 3 m  
**-MOTS**



**tichý motor S**  
Délka kabelu 3 m  
**-MOTSIS**

## + Control



**Switch Time®**  
**SWTIME**

Mechanicky nastavitelné koncové polohy na hlavě motoru bez možnosti nastavení mezipolohy.



Nikdy nezapojujte více motorů na jeden spínač bez užití relé.



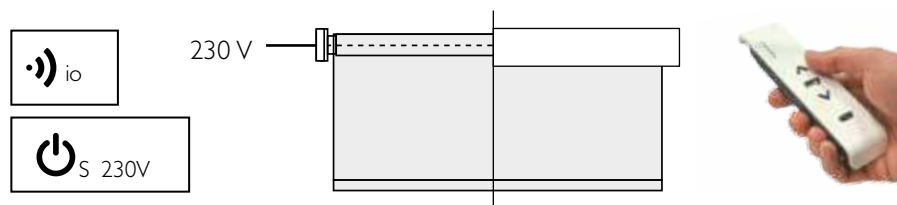

## Motor io pro bezdrátové ovládání

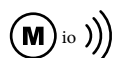

**motor io**

S integrovaným přijímačem, délka kabelu 3 m

**-MOTSIIOS**

## + dálkový ovladač io



1 kanálový ovladač přenosný

Situo io PURE

**SITUO1W**



5 kanálový ovladač přenosný

Situo io PURE

**SITUO5W**



1 kanálový ovladač nástěnný

Smoove Origin io

**ORIGINIO**

Elektronické nastavení s možností mezipolohy.

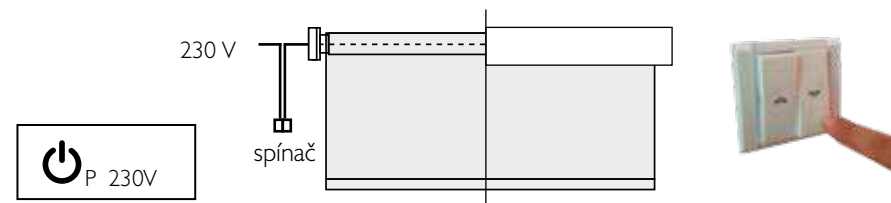

## Tichý motor PARALLEL pro bezdrátové ovládání



**Tichý motor P**

Délka kabelu 1 m

**-MOTSIPA**

## + Ovládání



**Switch Time®**

**SWTIME**

Elektronicky nastavitelné koncové polohy bez možnosti nastavení mezipolohy.



Lze zapojit více motorů na jeden spínač.

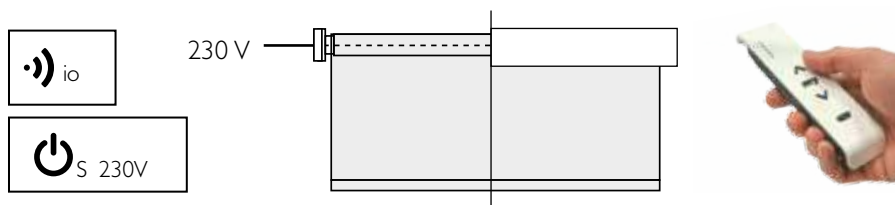

## Motor io pro bezdrátové ovládání

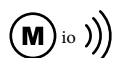

**motor io**  
S integrovaným přijímačem, délka kabelu 3 m  
**-MOTSIOS**

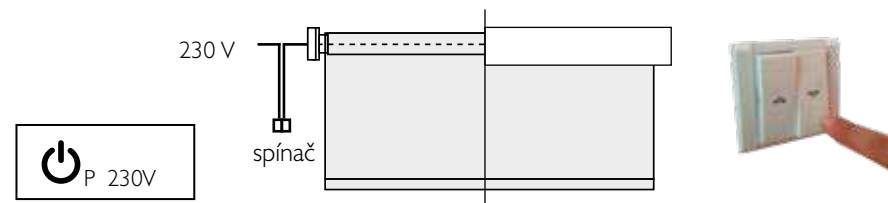

## Tichý motor PARALLEL pro drátové ovládání



**Tichý motor P**  
Délka kabelu 1 m  
**-MOTSIPA**

## + dálkový ovladač io



io )))  
**1 kanálový ovladač přenosný**  
Situo io PURE  
**SITUO1W**



io )))  
**5 kanálový ovladač přenosný**  
Situo io PURE  
**SITUO5W**



io )))  
**1 kanálový ovladač nástěnný**  
Smooove Origin io  
**ORIGINIO**

Elektronické nastavení s možností mezipolohy.



## + Ovládání



**Switch Time®**  
**SWTIME**

Elektronicky nastavitelné koncové polohy bez možnosti nastavení mezipolohy.



Lze zapojit více motorů na jeden spínač.